

NAVASTRID

Absperrtechnik



www.navastrid.de

1. Barrier posts	4
1.1 Barrier posts	5 - 14
1.2 Car-park barriers	15 - 18
1.3 Accessories	19
1.5 Ornamental bollards	21 - 22



2. Stainless steel post	24
2.1 Stainless steel barrier posts	25 - 28
2.2 Stainless steel bollards	29 - 30
2.3 Stainless steel hoops	31 - 33



3. Barrier elements	34
3.1 Tubular hoops	
3.2 Access barriers	
3.3 Height restriction barriers	
3.4 Protective railing	
3.5 City fence	



4. Barrier gates	54
4.1 Swing barriers	55 - 58
4.2 Access barriers	59 - 60
4.3 Manuel barriers	61 - 62



5. Outdoor equipment	64
5.1 Bicycle stands / lean-on hoops	65 - 74



6. Work site protection	76
6.1 Barrier posts	75 - 80
6.2 Protective hoops	81 - 88
6.3 Protective railings	89 - 91
6.4 Crash guards	92



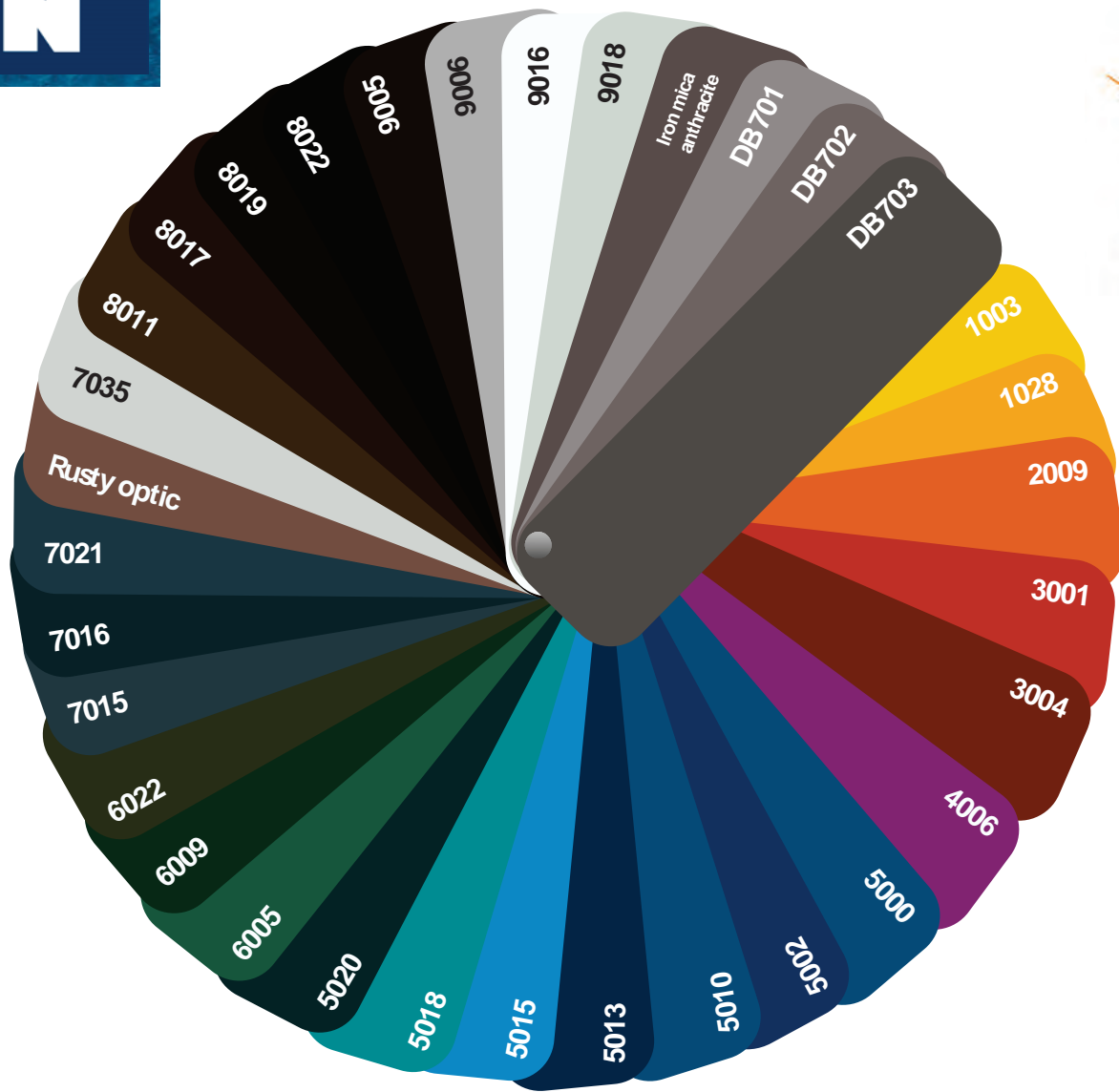

Eyelets
Inside Ø 20 mm
Outside Ø 35 mm

For round and square tube barriers



Triangular Lock
according to DIN 3223

For round and square tube barriers



Profile cylinder lock
with 3 keys
German branded product

For round and square tube barriers

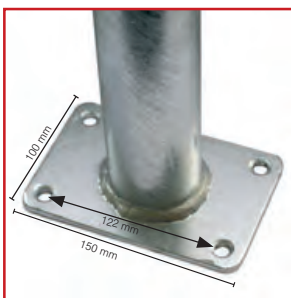

Bottom Plate

can be screwed onto a ground socket

Hole spacing: 70 x 122 mm

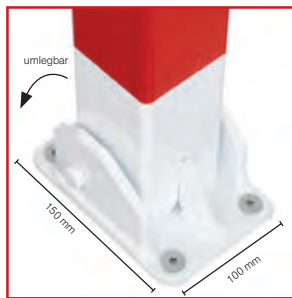

Hinged Bottom Plate

fixed with post and for titling



The Barrier posts are always hot-dip galvanized according to DIN EN ISO 1461. Bollards are made of high-quality aluminum or hot-dip galvanized steel.

Color Code - The information is non-binding with regard to color and brilliance. It is for the purpose of giving you an impression of the coatings we supply.

We reserve the right to make changes in design, appearance and function. Dimensions are approximate dimensions. No liability is assumed for any printing errors.



1. Barrier posts



1.1 Barrier posts	5 - 14
1.2 Car-park barriers	15 - 18
1.3 Accessories / sign posts	19
1.4 Ornamental bollards	21 - 22

Barrier Post - Steel tube Ø 60

N

This barrier or chain post can be used as a boundary post for pedestrian street, parking lot, road, security zone, etc. The barrier with the stable locking and easy handling guarantees a quick opening of the blockade

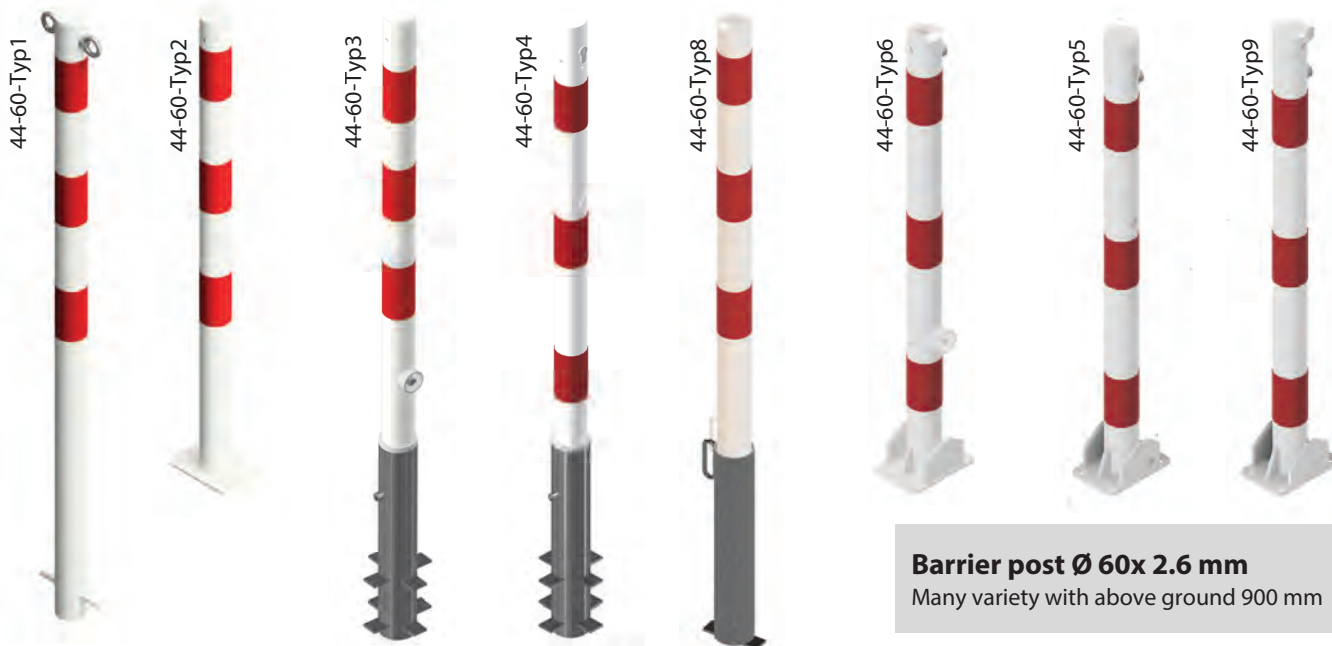

Barrier post Ø 60x 2.6 mm

Many variety with above ground 900 mm

Article.

- Stationary post for casting in concrete (with 2 eyelets)
- Stationary post to be fixed by plugs (with 2 eyelets)
- Removable post with Triangle lock and included ground socket (with 2 eyelets)
- Removable post with Euro profile cylinder lock and included ground socket (with 2 eyelets)
- Removable post for padlock and included ground socket (with 2 eyelets)
- Foldable post with Triangle lock
- Foldable post with Euro Profile cylinder lock
- Foldable post for padlock

Article no.

- 44-60-Typ1
- 44-60-Typ2
- 44-60-Typ3
- 44-60-Typ4
- 44-60-Typ8
- 44-60-Typ6
- 44-60-Typ5
- 44-60-Typ9

Weight.

- 5.4 kg
- 4.9 kg
- 7.8 kg
- 7.2 kg
- 7.7 kg
- 6.1 kg
- 6.3 kg
- 7.2 kg

Price (DAP)

- € 16.00
- € 15.00
- € 38.00
- € 35.00
- € 38.00
- € 30.00
- € 31.00
- € 35.00



The Barrier Post - Steel tube Ø 60 x 2.6 mm with welded steel cap and 900 mm above ground, are Hot Dip Galvanized and white coated with three 3M reflective stripes (color - RAL3001). The triangular locking mechanism made acc. with DIN 3223, self-engaging lock.

The foldable post with Euro profile lock, Triangular lock and Padlock, either fixed by plugs or with ground socket article no: 541-A6, available separately, Refer Page 19

Note: Order also accepted with only Hot Dip Galvanizing



Eyelets

inner diameter Ø20mm
outer diameter Ø35mm



44-76-Typ1



44-76-Typ2



44-76-Typ3



44-76-Typ4



44-76-Typ5



44-76-Typ6



Barrier post Ø 76 x 2.6 mm

Many variety with above ground 900 mm

Article.

Stationary post for casting in concrete (with 2 eyelets)

Stationary post to be fixed by plugs (with 2 eyelets)

Removable post with Triangle lock and included ground socket (with 2 eyelets)

Removable post with Euro profile cylinder lock and included ground socket (with 2 eyelets)

Foldable post with Triangle lock

Foldable post with Euro profile cylinder lock

Article no.

44-76-Typ1

44-76-Typ2

44-76-Typ3

44-76-Typ4

44-76-Typ5

44-76-Typ6

Weight.

6.8 kg

5.5 kg

10.7 kg

11.1 kg

7.0 kg

8.4 kg

Price (DAP)

€ 21.00

€ 17.00

€ 52.00

€ 54.00

€ 34.00

€ 41.00



The Barrier Post - Steel tube Ø76x 2.6 mm with welded steel cap 900 mm above ground. The foldable post with Euro profile cylinder lock and Triangular lock either fixed by plugs or with ground socket article no: 541-A6, available separately, Refer Page 19.

Note: Order also accepted with only Hot Dip Galvanizing

Also available in yellow/black, see work site protection pages 129 ff



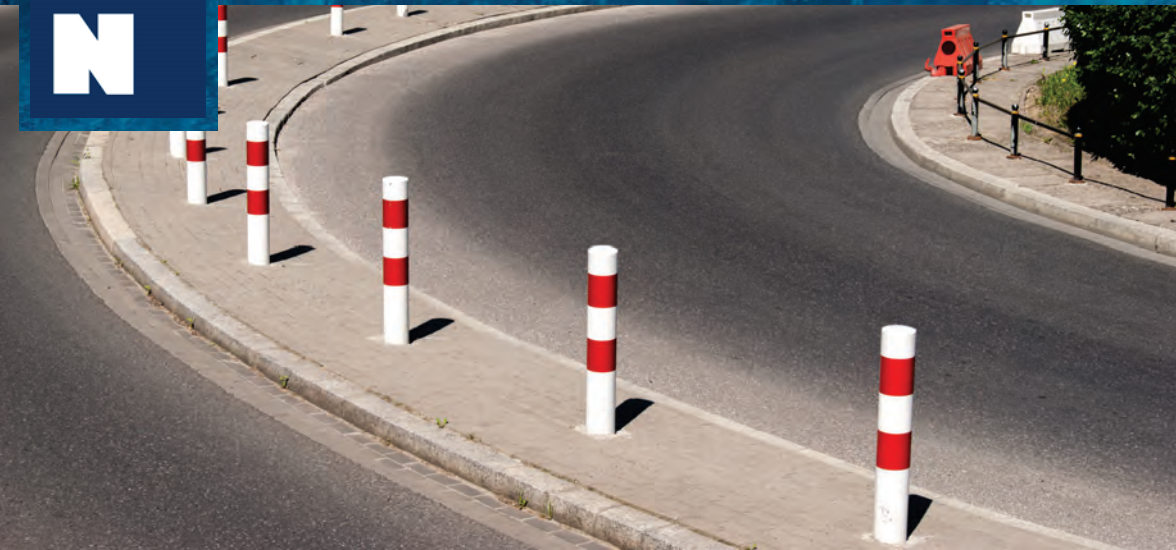

44-101-Typ1



44-101-Typ2



44-101-Typ3



Steel tube bollards Ø 101 x 3 mm

Stationary for casting in concrete

Steel tube bollards Ø 101 x 3 mm

for temporary removable including ground socket

Article.

Stationary post for casting in concrete, Length 1300mm

Stationary post to be fixed by plugs, Length 1000mm

Removable post with Triangle lock and included ground socket, Length 900mm

Article no.

44-101-Typ1

44-101-Typ2

44-101-Typ3

Weight.

10.4 kg

10.4 kg

11.5 kg

Price (DAP)

€ 34.00

€ 34.00

€ 56.00



The Barrier Post - Steel tube Ø 101 x 3 mm with welded steel cap and 900 mm above ground, are Hot Dip Galvanized and white coated with three 3M reflective stripes (color - RAL3001). The triangular locking mechanism made acc. with DIN 3223, self-engaging lock.

Note: Order also accepted with only Hot Dip Galvanizing



Steel tube bollards Ø 152 x 3.6 mm
Stationary for casting in concrete

Steel tube bollards Ø 152 x 3.6 mm
for temporary removable including ground socket

Article.	Article no.	Weight.	Price (DAP)
Stationary bollards for casting in concrete, Length 1200mm	44-152-Typ1A	17.6 kg	€ 58,00
Stationary bollards for casting in concrete, Length 1500mm	44-152-Typ1B	21.8kg	€ 72,00
Stationary bollards for casting in concrete, Length 2000mm	44-152-Typ1C	28.8 kg	€ 95,00
Stationary bollards to be fixed by plugs, Length 1000mm	44-152-Typ2	17.7 kg	€ 58,00
Removable bollards without lock and included ground socket, Length 1500mm	44-152-Typ3A	32.8 kg	€ 108,00
Removable bollards without lock and included ground socket, Length 2000mm	44-152-Typ3B	39.8 kg	€ 132,00
Removable bollards with Triangular lock and included ground socket, Length 1000mm	44-152-Typ4	21.7 kg	€ 106,00



Note: Order also accepted with only Hot Dip Galvanizing

Also available in yellow/black, see work site protection pages 129 ff





44-193-Typ1-B



44-193-Typ2



44-193-Typ3-A



44-193-Typ4

Steel tube bollards Ø 193 x 3.6 mm

Stationary for casting in concrete

Steel tube bollards Ø 193 x 3.6 mm

for temporary removable including ground socket

Article.

- Stationary bollards for casting in concrete, Length 1200mm
- Stationary bollards for casting in concrete, Length 1500mm
- Stationary bollards for casting in concrete, Length 2000mm
- Stationary bollards to be fixed by plugs, Length 1000mm
- Removable bollards without lock and included ground socket, Length 1500mm
- Removable bollards without lock and included ground socket, Length 2000mm
- Removable bollards with Triangular lock and included ground socket, Length 1000mm

Article no.	Weight.	Price (DAP)
44-193-Typ1-A	22.5 kg	€ 74,00
44-193-Typ1-B	27.9 kg	€ 92,00
44-193-Typ1-C	36.8 kg	€ 122,00
44-193-Typ2	27.1 kg	€ 90,00
44-193-Typ3-A	27.6 kg	€ 91,00
44-193-Typ3-B	51.0 kg	€ 169,00
44-193-Typ4	25.7 kg	€ 126,00



These post are Hot Dip Galvanized and white coated with three reflective three 3M reflective stripes (color - RAL3001). The triangular locking mechanism made acc. with DIN 3223, self-engaging lock.

Note: Order also accepted with only Hot Dip Galvanizing



These heavy bollards can be used as collision protection, especially in front of entrances, halls, petrol stations, etc. They can also protect roof overhangs or serve as a guide Bollards in front of ramps, gates etc.

Steel tube bollards Ø 273 x 5.0 mm
Stationary, for casting in concrete with welded steel cap



Article.

- Stationary bollards for casting in concrete, Length 1500mm
- Stationary bollards for casting in concrete, Length 2000mm
- Stationary bollards to be fixed by plugs, Length 1500mm

Article no.	Weight.	Price (DAP)
44-273-Typ1-A	51.3 kg	€ 170,00
44-273-Typ1-B	72.0 kg	€ 224,00
44-273-Typ2	62.5 kg	€ 195,00

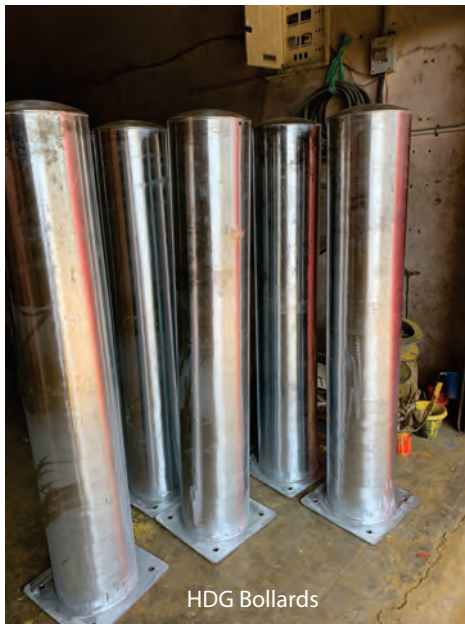

HDG Bollards



Stickered Bollards



Packed Bollards

Barrier Post - Steel tube 70 x 70 (Unfoldable)

N



These barrier posts can be opened both with a Euro profile cylinder key and a triangular wrench that conforms with DIN 3232. This ensures that the fire brigade and rescue services have access at any time.

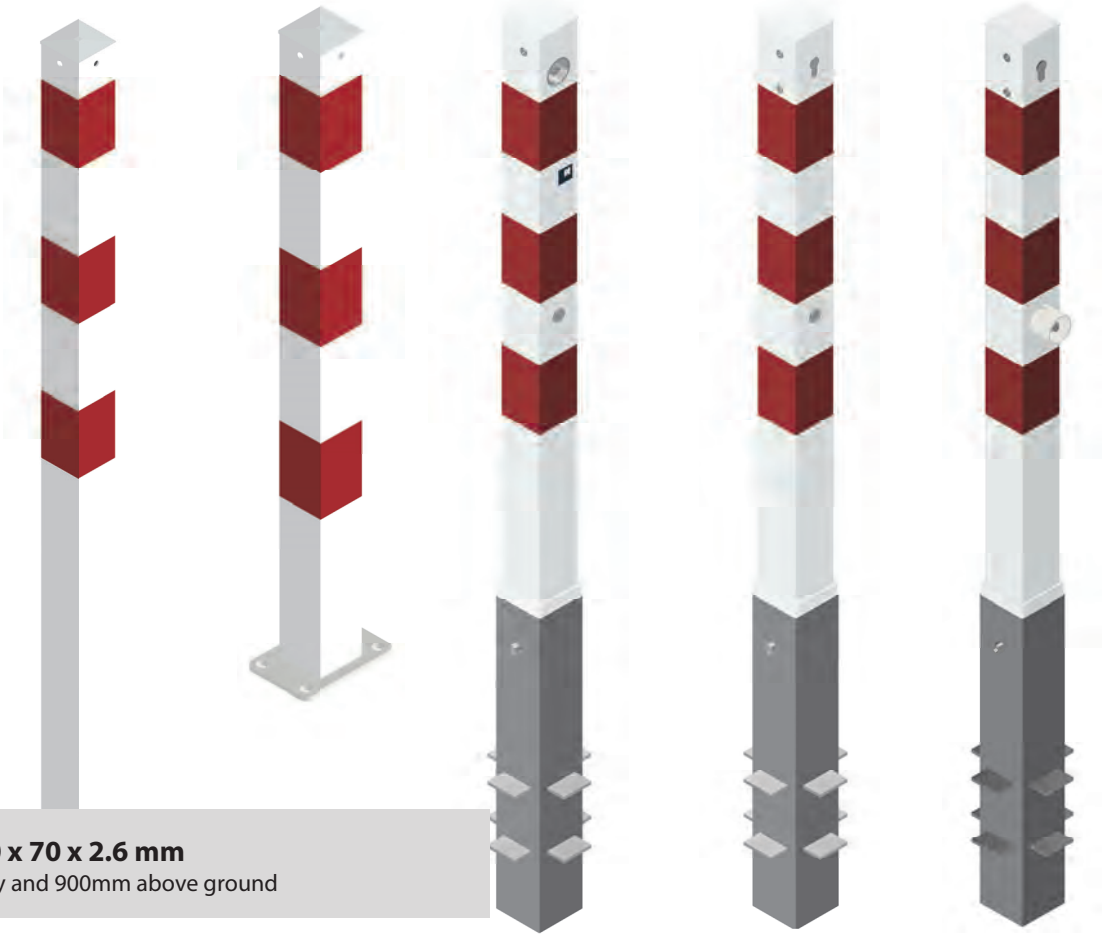

Barrier post 70 x 70 x 2.6 mm
removable with key and 900mm above ground

Article.

- Stationary post for casting in concrete, Length 100mm
- Stationary post to be fixed by plugs
- Removable post with Triangle lock and included ground socket
- Removable post with Euro profile cylinder lock and included ground socket
- Removable post with **Combo** "Triangle & Euro profile cylinder lock "and included ground socket

Article no.

- 55-70-Typ1
- 55-70-Typ2
- 55-70-Typ5
- 55-70-Typ4
- 55-70-Typ7

Weight. Price (DAP)

- 7.7 kg € 25,00
- 6.9 kg € 22,00
- 15.5 kg € 76,00
- 14.3 kg € 70,00
- 14.2 kg € 70,00



These stationary and removable Post are Hot Dip Galvanized and white coated with three 3M reflective stripes (color - RAL3001). The triangular locking mechanism made acc. with DIN 3223, self-engaging lock.

Note: Order also accepted with only Hot Dip Galvanizing and Option for post with eyelets too available

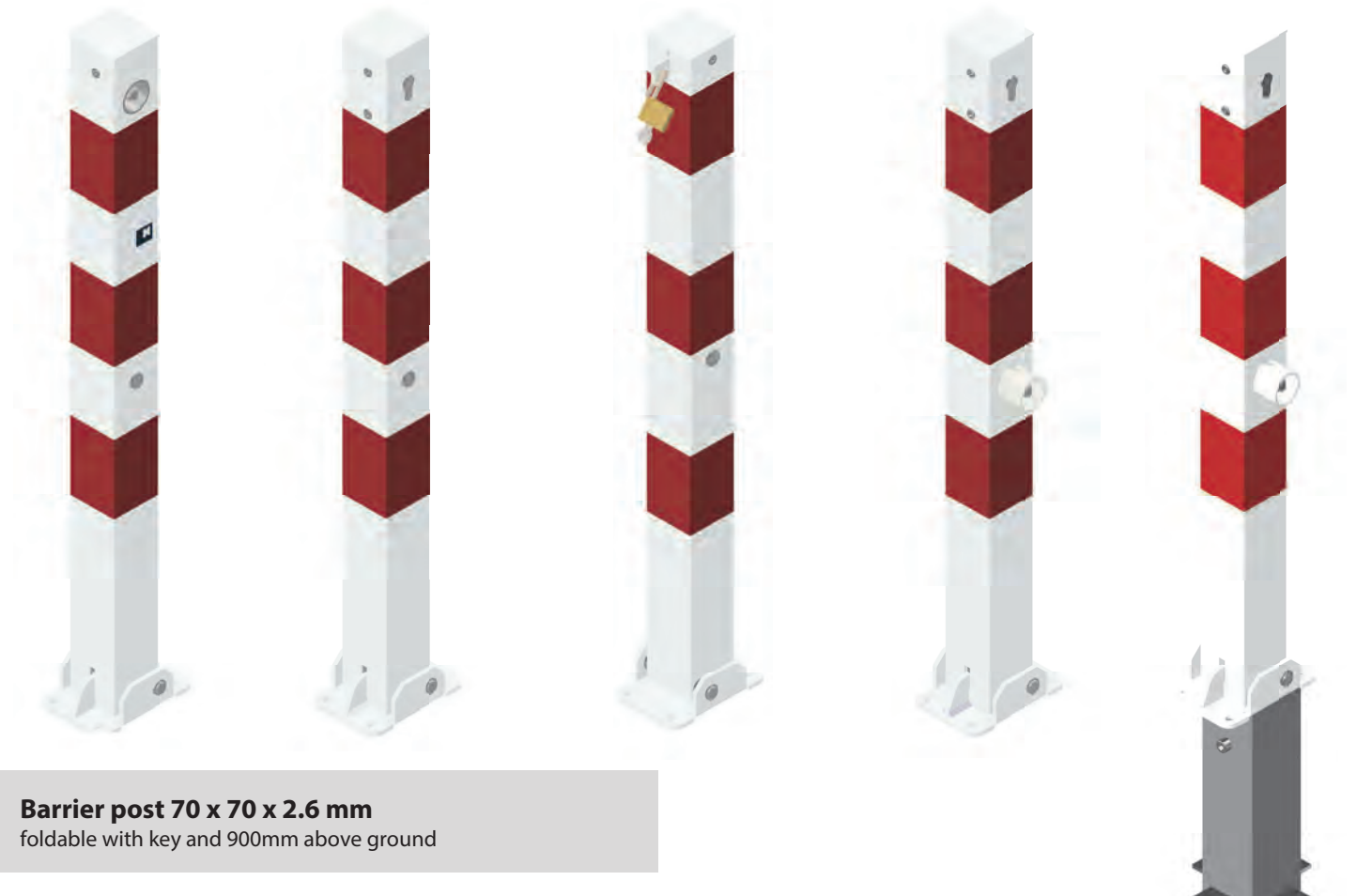

Barrier post 70 x 70 x 2.6 mm
foldable with key and 900mm above ground

Article.

- Foldable post with Triangle lock
- Foldable post with Euro profile cylinder lock
- Foldable post with hook (option to lock with padlock)
- Foldable post with **Combo** "Triangle & Euro profile cylinder lock "
- Foldable & Removable post with **Combo** "Triangle & Euro profile cylinder lock "and incl ground socket

Article no.

- 55-70-Typ6
- 55-70-Typ3
- 55-70-Typ10
- 55-70-Typ8
- 55-70-Typ9

Weight.

- 8.7 kg
- 8.7 kg
- 8.1 kg
- 7.6 kg
- 13.4 kg

Price (DAP)

- € 43,00
- € 43,00
- € 40,00
- € 37,00
- € 66,00



The Barrier Post - Steel tube 70 x 70 mm with welded steel cap 900 mm above ground, are foldable post with Euro profile cylinder lock and Triangular lock either fixed by plugs or with ground socket article no: 541-A6, available separately, Refer Page 19.

Note: Order also accepted with only Hot Dip Galvanizing and Option for post with eyelets too available

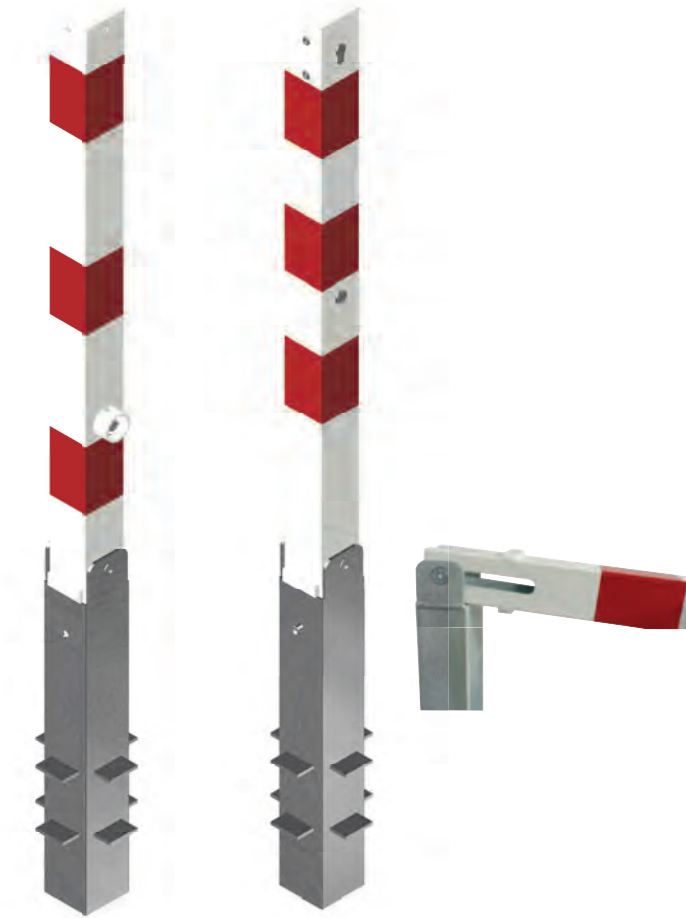
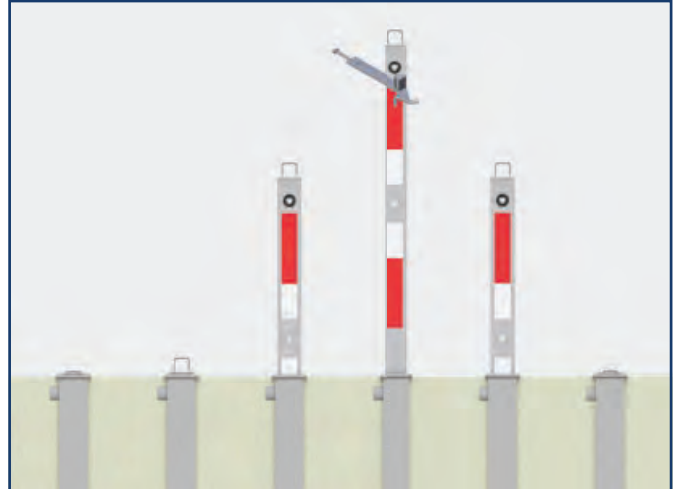
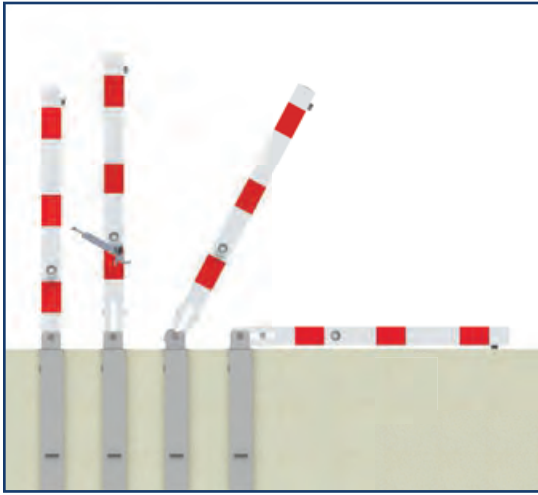

Barrier post 70 x 70 x 2.6 mm

Foldable, with locking with lifting and tilting mechanism,

Barrier post 70 x 70 x 2.6 mm

Fully retractable with locking system

Article.

- Foldable post with Triangle lock
- Foldable post with Euro profile cylinder lock
- Retractable post with Triangle lock
- Retractable post with Euro profile cylinder lock

Article no.

- 55-70-Typ11
- 55-70-Typ12
- 55-70-Typ13
- 55-70-Typ14

Weight.

- 12.6 kg
- 12.1 kg
- 16.8 kg
- 17.1 kg

Price (DAP)

- € 62,00
- € 59,00
- € 82,00
- € 84,00



Note: Order also accepted with only Hot Dip Galvanizing

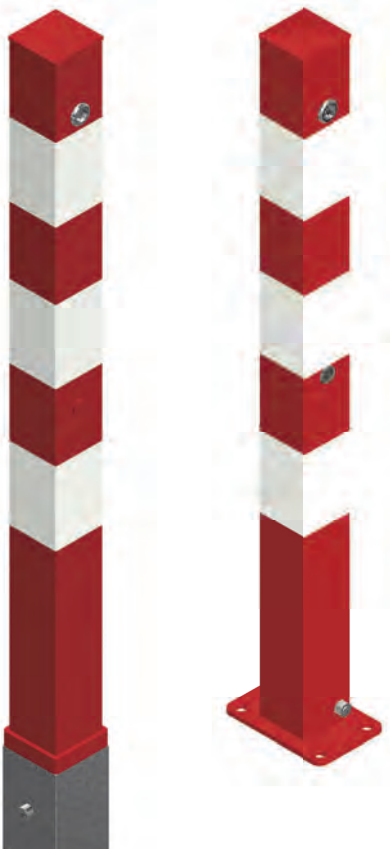

with 8mm triangular lock



8mm key
Article no N575



Barrier post 70 x 70 x 2.6 mm - With 8 mm triangular locking alternative to the conventional triangular lock

Barrier post 70 x 70 x 2.6 mm - This 500 mm high post is very suitable for parking situation without enough space

Article.

- Removable post with 8mm Triangle lock and included ground socket
- Fordable post with 8mm Triangle lock
- Foldable post with Triangle lock, above ground 500mm
- Foldable post with Euro profile cylinder lock , above ground 500mm

Article no.

- 55-70-Typ15
- 55-70-Typ16
- 55-70-Typ17
- 55-70-Typ18

Weight.

- 12.8 kg
- 8.5 kg
- 6.5 kg
- 6.2 kg

Price (DAP)

- € 63,00
- € 42,00
- € 32,00
- € 30,00



These post are Hot Dip Galvanized and coated with 3M reflective stripes (color - RAL3001). The triangular locking mechanism made acc. with DIN 3223, self-engaging lock. the foldable post with Euro profile cylinder lock and Triangular lock either fixed by plugs or with ground socket article no: 541-A6, available separately, Refer Page 19.

Note: Order also accepted with only Hot Dip Galvanizing



Passage and car-park barriers

Square tube 70 x 70 mm with lateral round tube hoops with width approx. 800 mm and above ground 500 mm

Passage and car-park barriers

Square tube 70 x 70 mm with lateral round tube hoops with width approx. 800 mm and above ground 900 mm

Article.

- Foldable Car park barrier with triangular locking (above ground 500 mm)
- Foldable Car park barrier with Euro profile cylinder lock (above ground 500 mm)
- Foldable Car park barrier with triangular locking (above ground 900 mm)
- Foldable Car park barrier with Euro profile cylinder lock (above ground 900 mm)
- Removable Car park barrier with Triangle lock and included ground socket
- Removable Car park barrier with Euro profile cylinder lock and included ground socket

Article no.

- 61-70-Typ3
- 61-70-Typ4
- 60-70-Typ3S
- 61-70-Typ2
- 60-70-Typ5S
- 61-70-Typ1

Weight.

- 7.8 kg
- 9.1 kg
- 10.7 kg
- 12.0 kg
- 7.0 kg
- 22.0 kg

Price (DAP)

- € 38.00
- € 45.00
- € 52.00
- € 59.00
- € 34.00
- € 108.00



The Car park barrier - Steel tube 70 x 70 mm with welded steel cap 900 mm above ground, are foldable post with Euro profile cylinder lock and Triangular lock either fixed by plugs or with ground socket article no: 541-A6, available separately, Refer Page 19.

Note: Order also accepted with only Hot Dip Galvanizing



Key Lock

with 8mm triangular lock

Passage and car-park barriers
 Square tube 70 x 70 mm with lateral round tube hoops with width approx. 800 mm and above ground 500 mm

Passage and car-park barriers
 Square tube 70 x 70 mm with lateral round tube hoops with width approx. 800 mm and above ground 900 mm

Article.	Article no.	Weight.	Price (DAP)
Foldable Car park barrier with Euro profile cylinder lock (above ground 500 mm)	61-70-Typ8	9.1 kg	€ 39.00
For casting in concrete Car park barrier with Euro profile cylinder lock (above ground 500 mm)	61-70-Typ7	7.6 kg	€ 32.00
Foldable Car park barrier with 8mm triangle lock (above ground 500 mm)	61-70-Typ10	9.1 kg	€ 39.00
For casting in concrete Car park barrier with 8mm triangle lock (above ground 500 mm)	61-70-Typ9	7.6 kg	€ 32.00



The Barrier Post - Steel tube 70 x 70 mm with welded steel cap 900 mm above ground, are foldable post with Euro profile cylinder lock and Triangular lock , either fixed by plugs or with ground socket article no: 541-A6, available separately, Refer Page 1976.

Note: Order also accepted with only Hot Dip Galvanizing and Option for post with eyelets too available



Crash proof car-park barriers

Square tube 70 x 70 mm with flexible to impact and thrust width approx. 800 mm and above ground 500 mm

Car-park barrier, foldable

tube Ø 60 mm with lateral round tube hoops and base plate width: approx. 800 mm and above ground 500 mm

Article.

Crash proof car-park barriers with Euro profile cylinder lock (above ground 500 mm)
Car-park barrier, foldable with Euro profile cylinder lock (above ground 500 mm)

Article no.

61-70-Typ6
61-70-Typ11

Weight.

10.1 kg
8.1 kg

Price (DAP)

€ 55,00
€ 44,00



Note: Order also accepted with only Hot Dip Galvanizing



Car park barrier
 Made of thick-walled round steel tube \varnothing 33.7 x 2.5 mm height approx. 450 mm, width approx. 850 mm, extremely flat when folded down, approx. 45 mm high



61-70-Typ12



61-70-Typ13



61-70-Typ14

Article.

- Foldable Car park barrier with padlocking (above ground 450 mm)
- Foldable Car park barrier with Euro profile cylinder lock (above ground 450mm)
- Foldable Car park barrier with Euro profile cylinder lock with baseplate (above ground 450mm)

Article no.

- 61-70-Typ12
- 61-70-Typ13
- 61-70-Typ14

Weight.

- 8.5 kg
- 8.2 kg
- 8.5 kg

Price (DAP)

- € 47,00
- € 45,00
- € 47,00



Note: Order also accepted with only Hot Dip Galvanizing



Multipurpose wrench, Triangular Key for posts and barriers

Article no. N570 - Grey cast multipurpose wrench made acc. with DIN 3223, for all barrier posts with triangular locking mechanism and for opening the covers

Article no. N571 - Triangle wrench made acc. with DIN 3223, for all barrier posts with triangular lock

Article.	Article no.	Weight.	Price (DAP)
Multipurpose wrench	N570	0.4 kg	€ 3,90
Triangular wrench	N571	0.2 kg	€ 2,90
Square socket wrench (6mm)	N573	0.2 kg	€ 2,00
Triangular wrench (8mm)	N575	0.1 kg	€ 2,20



Ground sockets and cover for Barrier Post - Steel tube Ø 60

Article.	Article no.	Weight.	Price (DAP)
Ground socket for Barrier post Ø 60 mm without locking mechanism	541-A3	2.1 kg	€ 7,70
Ground socket for Barrier post Ø 60 mm with locking mechanism	541-A4	2.1 kg	€ 7,70
Ground socket for Barrier post Ø 60 mm locking mechanism for pad lock	541-A5	2.3 kg	€ 8,40
Ground socket with mounted plate 100 x 150 (for folding barrier)	541-A6	3.0 kg	€ 11,00
Cover for Ø 60 ground socket without locking mechanism	N561	0.7 kg	€ 2,60
Cover for Ø 60 ground socket with locking mechanism (open by Multipurpose wrench)	N562	1.0 kg	€ 3,70



Ground sockets and cover for Barrier Post - Steel tube Ø 60 mm & Sq 70 x 70 mm

Article.	Article no.	Weight.	Price (DAP)
Ground socket for Barrier post Ø 76 mm without locking mechanism	541-A8	3.3 kg	€ 12,10
Ground socket for Barrier post Ø 76 mm with locking mechanism	541-A9	3.3 kg	€ 17,80
Cover for Ø 76 ground socket without locking mechanism	N563	0.3 kg	€ 1,10
Cover for Ø 76 ground socket with locking mechanism (open by Multipurpose wrench)	N564	0.7 kg	€ 2,60
Ground socket for Barrier post Sq 70 x 70 mm without locking mechanism	541-A1	4.4 kg	€ 16,10
Ground socket for Barrier post Sq 70 x 70 mm with locking mechanism	541-A2	4.4 kg	€ 16,10
Cover for Sq 70 x 70 mm ground socket without locking mechanism	N565	0.4 kg	€ 1,50
Cover for Sq 70 x 70 mm ground socket with locking mechanism (open by Multipurpose wrench)	N566	0.8 kg	€ 3,00

Ornamental bollards - overview types of head



Ø 60 mm
Series N565D



Ø 60 mm
Series N566D



Ø 76 mm
Series N575D



Ø 82 mm
Series N584D



Ø 82 mm
Series N585D



Ø 89 mm
Series N588D

Ø 76 mm
Series N574D

Ø 76 mm
Series N578D

Ø 102 mm
Series N592D



Ø 60 mm
Series N568D



Ø 60 mm / Ø 82 mm
Series N564D/N582D



Ø 82 mm
Series N580D



Ø 82 mm
Series N581D



Ø 76 mm
Series N577D



Ø 76 mm
Series N5074D

Ø 89 mm
Series N587D

Ø 150 mm / Ø 193 mm
Series N50155D / N5195D

Ø 102mm
Series N596D

Ø 89 mm
Series N5084D

Ø 102 mm
Series N594D

Ø 100 mm
Series N50101D

Ø 120 mm
Series N50120D / N50121D



Ø 60 / 110 mm
Series N590D



Ø 72 / 160 mm
Series N595D
Pages 69 / 70



Ø 76 / 100 mm
Series N579D



Ø 76 / 102 mm
Series N50102D



Ø 96 / 168 mm
Series N50168D



Ø 108 mm
Series N597D



Ø 140 mm
Series N50140D



70 x 70 mm
Series N573D



70 x 70 mm
Series N5073D



70 x 70 mm
Series N50731D



70 x 70 mm
Series N5071D

100 x 100 mm
Series N5075D

Know INDIA - Kathakali, Kathak is a major form of classical Indian dance. It is a "story play" genre of art, but one distinguished by the elaborately colorful make-up, costumes and face masks that the traditionally male actor-dancers wear.





2. Stainless steel post

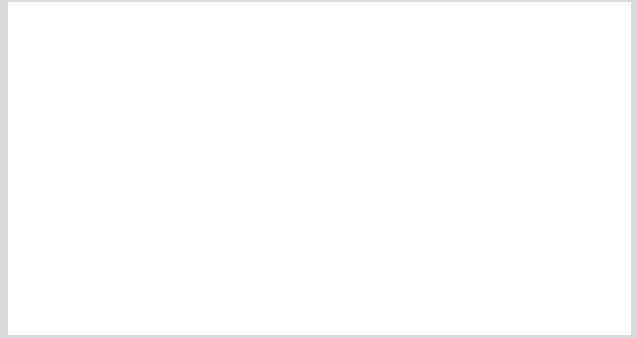

Stainless steel post (Category)

Is under designing and pricing fixing...
Soon we send you updated catalogue.

Keeping scrolling down for other products



3. Barrier elements

3.1 Tubular hoops	85 - 93
3.2 Access barriers	94 - 96
3.3 Height restriction barriers	97 - 100
3.4 Protective railing	101 - 106
3.5 City fence	107 - 109



Barrier Elements (Category)

Is under designing and pricing fixing...
Soon we send you updated catalogue

Keeping scrolling down for other products



4. Barrier gates



- | | |
|---------------------|-------------|
| 4.1 Swing barriers | 55 - 58, 63 |
| 4.2 Access barriers | 59 - 60 |
| 4.3 Manuel barriers | 61 - 62 |

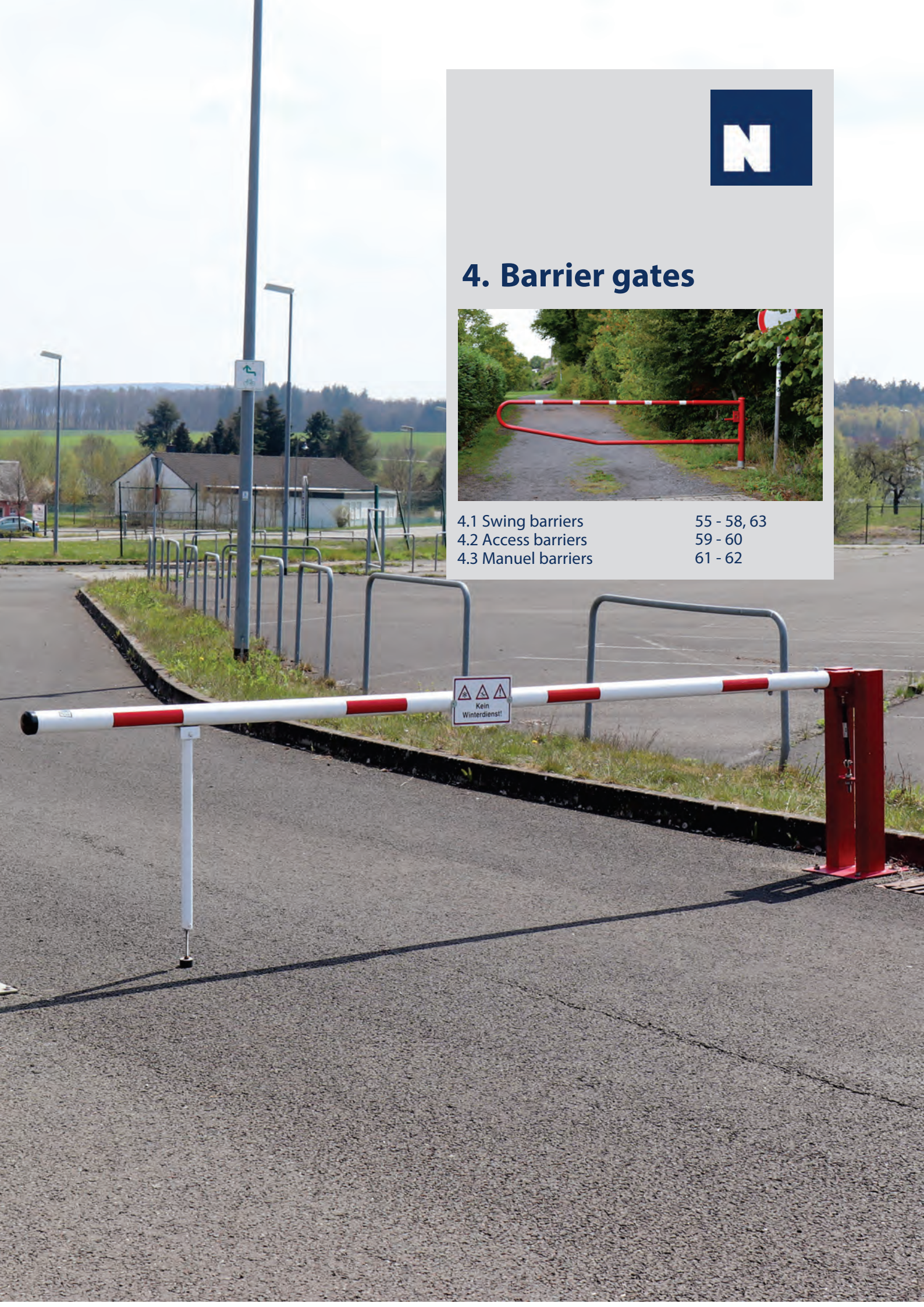



Swing barrier

barrier swings horizontally with no supporting post. Locking mechanism can be closed or opened using a locking pin latching automatically in four positions (every 90°), fitted for a padlock or with triangular locking mechanism acc. to DIN 3223 or Euro profile cylinder lock

Swiveling post: Steel tube Ø 102 mm

Barrier arm: Steel tube Ø 60 mm

Height: Approx. 950 mm above ground

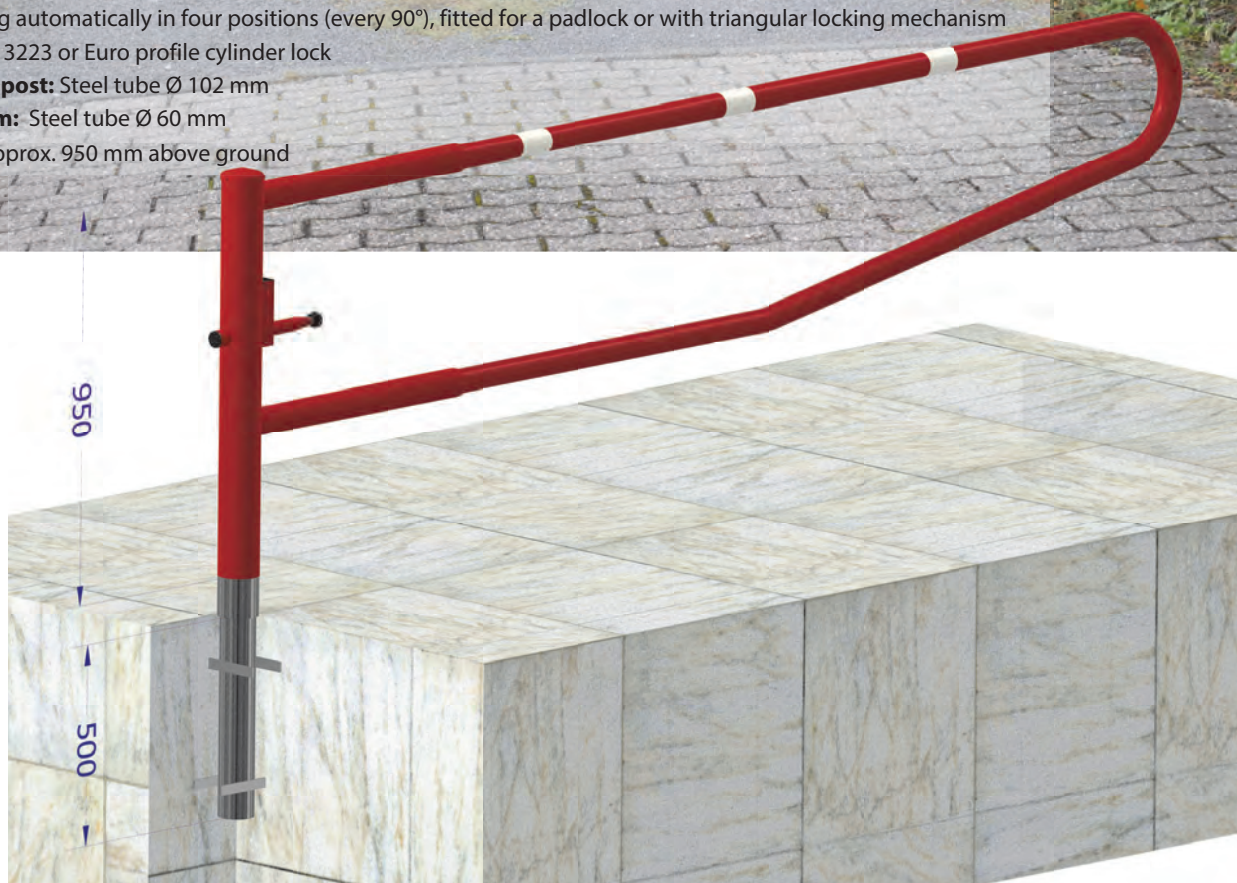

Padlock lock

Triangular lock

Euro cylinder lock

Article.	Weight.	Article no.	Price (DAP)	Article no.	Price (DAP)	Article no.	Price (DAP)
Swiveling gates - 1500 mm	33.0 kg	77-1-15-P	€ 274,00	77-1-15-T	€ 335,00	77-1-15-C	€ 361,00
Swiveling gates - 2000 mm	36.5 kg	77-1-20-P	€ 288,00	77-1-20-T	€ 348,00	77-1-20-C	€ 375,00
Swiveling gates - 2500 mm	40.0 kg	77-1-25-P	€ 301,00	77-1-25-T	€ 361,00	77-1-25-C	€ 388,00
Swiveling gates - 3000 mm	43.5 kg	77-1-30-P	€ 328,00	77-1-30-T	€ 375,00	77-1-30-C	€ 402,00
Swiveling gates - 3500 mm	47.0 kg	77-1-35-P	€ 341,00	77-1-35-T	€ 388,00	77-1-35-C	€ 415,00



These gates are Hot Dip Galvanized and red coated with white reflecting sticker
 Optionally available with: Base plate for plugging down, 360 x 360 x 8 mm including 4 holes Ø 21 mm hole pitch 260 x 260 mm
 Recommended foundation dimensions: width: 550 x 550 mm depth: 900 mm
 Note: Order also accepted with HDG



Swing barrier

barrier swings horizontally with no supporting post. Locking mechanism can be closed or opened using a locking pin latching automatically in four positions (every 90°), fitted for a padlock or with triangular locking mechanism acc. to DIN 3223 or Euro profile cylinder lock

Swiveling post: Steel tube Ø 102 mm

Barrier arm: Steel tube 60 x 40 mm

Height: Approx. 950 mm above ground



Article.	Weight.	Padlock lock		Triangular lock		Euro cylinder lock	
		Article no.	Price (DAP)	Article no.	Price (DAP)	Article no.	Price (DAP)
Swiveling gates - 1500 mm	33.0 kg	77-2-15-P	€ 221,00	77-2-15-T	€ 281,00	77-2-15-C	€ 241,00
Swiveling gates - 2000 mm	37.0 kg	77-2-20-P	€ 234,00	77-2-20-T	€ 294,00	77-2-20-C	€ 328,00
Swiveling gates - 2500 mm	41.0 kg	77-2-25-P	€ 247,00	77-2-25-T	€ 308,00	77-2-25-C	€ 341,00
Swiveling gates - 3000 mm	44.5 kg	77-2-30-P	€ 261,00	77-2-30-T	€ 321,00	77-2-30-C	€ 355,00
Swiveling gates - 3500 mm	48.0 kg	77-2-35-P	€274,00	77-2-35-T	€ 335,00	77-2-35-C	€ 368,00



These gates are Hot Dip Galvanized and white coated with red reflecting sticker

Optionally available with: Base plate for plugging down, 360 x 360 x 8 mm including 4 holes Ø 21 mm hole pitch 260 x 260 mm

Recommended foundation foundation dimensions: width: 550 x 550 mm depth: 900 mm

Note: Order also accepted with HDG



Swing barrier

barrier can be swiveled horizontally, with pull rope reinforcement. Locking mechanism closed or opened by locking pin in four positions (every 90°), fitted for a padlock or with triangular locking mechanism acc. to DIN 3223 or Euro profile cylinder lock.

Swiveling post: Steel tube Ø 102 mm, hot-dip galvanized and coated red

Barrier arm: Aluminum tube 100 x 50 mm, coated white with red reflecting stripes

Height: Approx. 1000 mm above ground

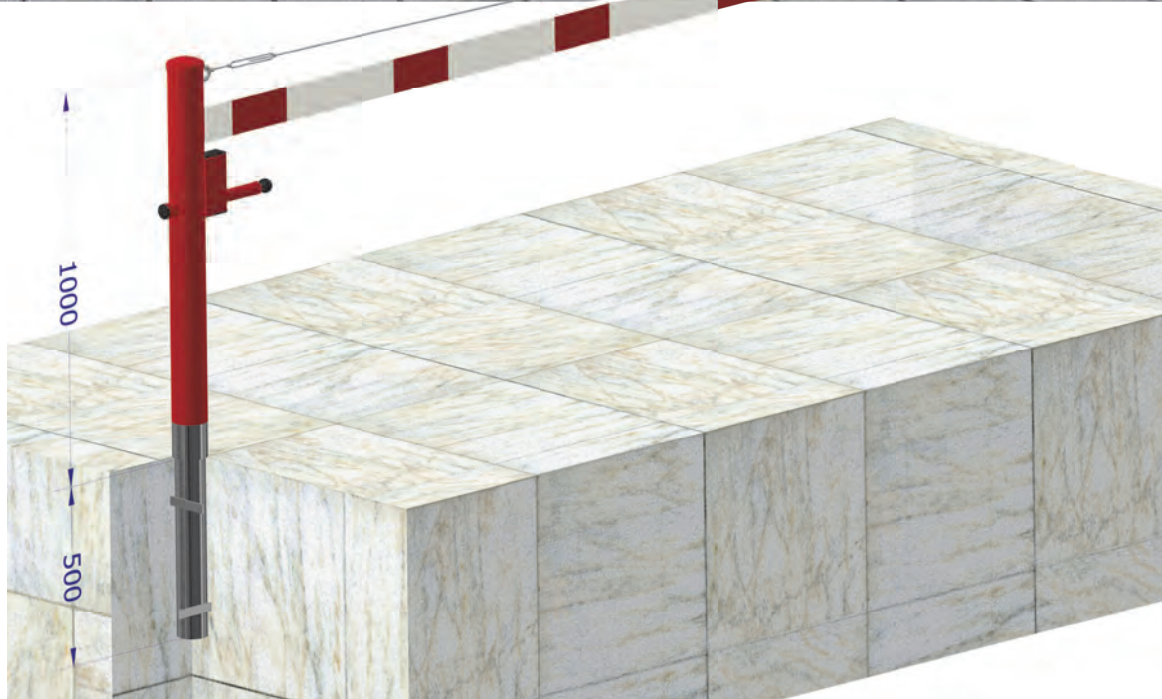

Padlock lock

Triangular lock

Euro cylinder lock

Article.	Weight.	Article no.	Price (DAP)	Article no.	Price (DAP)	Article no.	Price (DAP)
Swiveling gates - 1500 mm	32.0 kg	77-3-15-P	€ 258,00	77-3-15-T	€ 318,00	77-3-15-C	€ 240,00
Swiveling gates - 2000 mm	35.0 kg	77-3-20-P	€ 271,00	77-3-20-T	€ 331,00	77-3-20-C	€ 250,00
Swiveling gates - 2500 mm	38.0 kg	77-3-25-P	€ 284,00	77-3-25-T	€ 345,00	77-3-25-C	€ 260,00
Swiveling gates - 3000 mm	41.0 kg	77-3-30-P	€ 298,00	77-3-30-T	€ 358,00	77-3-30-C	€ 270,00
Swiveling gates - 3500 mm	44.0 kg	77-3-35-P	€ 311,00	77-3-35-T	€ 371,00	77-3-35-C	€ 280,00



These gates are Hot Dip Galvanized and red & white coated with red reflecting sticker

Optionally available with: Base plate for plugging down, 360 x 360 x 8 mm including 4 holes Ø 21 mm hole pitch 260 x 260 mm

Recommended foundation dimensions: width: 550 x 550 mm depth: 900 mm

Note: Order also accepted with HDG



Swing barrier

barrier can be swiveled horizontally, with bracing tube and pull rope reinforcement. Locking mechanism at the swiveling post closed or opened by locking pin in 4 positions (every 90°), fitted for a padlock or with triangular locking mechanism acc. to DIN 3223 or Euro profile cylinder lock, including two supporting posts.

Swiveling post: Steel tube Ø 102 mm, hot-dip galvanized and red coated

Barrier arm: Aluminium tube 100 x 50 mm, coated white with red reflecting stripes

Supporting post: Steel tube 70 x 70 mm, hot-dip galvanized and white coated (2 piece)

Height: Approx. 1000 mm above ground

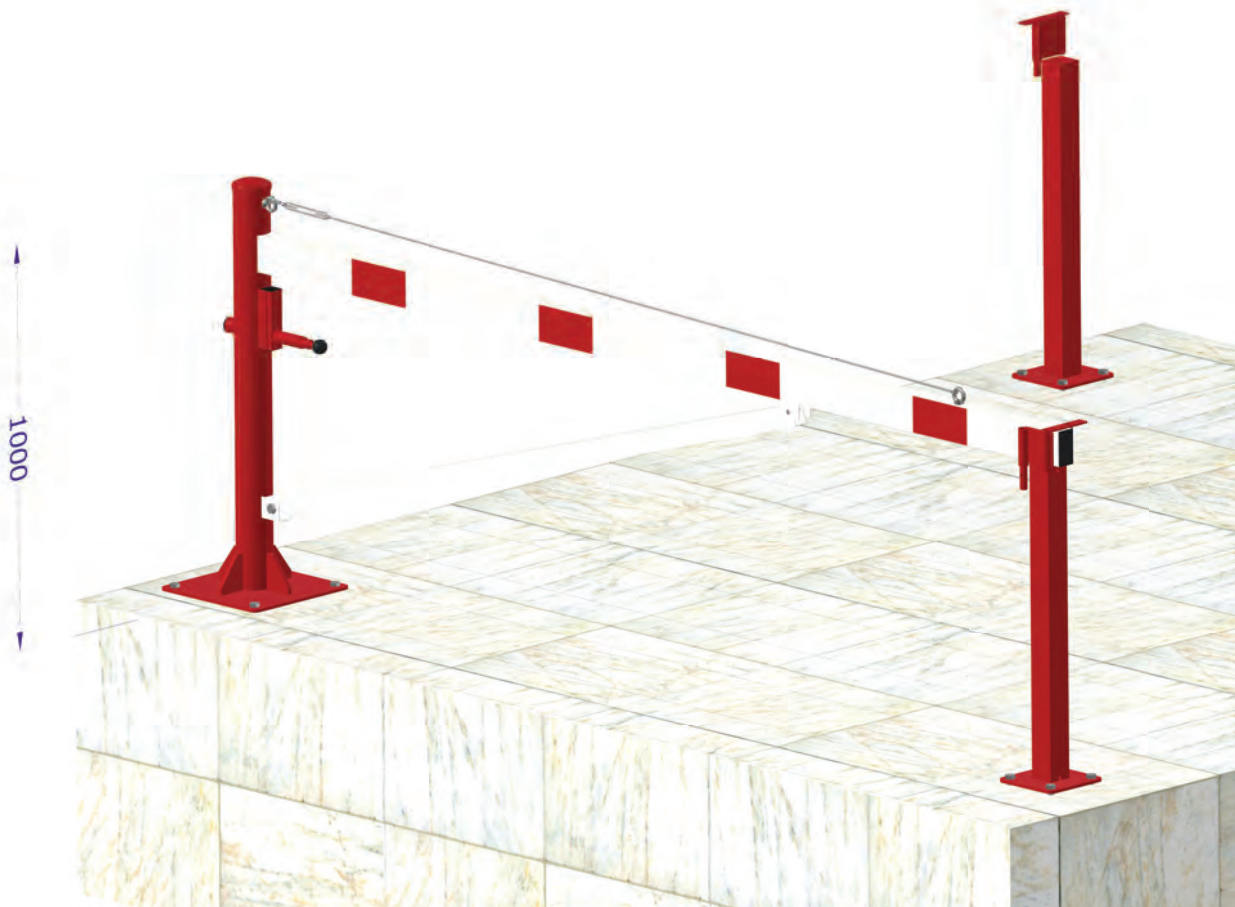

Article.	Weight.	Padlock lock		Triangular lock		Euro cylinder lock	
		Article no.	Price (DAP)	Article no.	Price (DAP)	Article no.	Price (DAP)
Swiveling gates - 3000 mm	58.0 kg	77-4-30-P	€ 338,00	77-4-30-T	€ 371,00	77-4-30-C	€ 408,00
Swiveling gates - 3500 mm	61.0 kg	77-4-35-P	€ 355,00	77-4-35-T	€ 388,00	77-4-35-C	€ 425,00
Swiveling gates - 4000 mm	65.0 kg	77-4-40-P	€ 371,00	77-4-40-T	€ 405,00	77-4-40-C	€ 442,00
Swiveling gates - 4500 mm	69.0 kg	77-4-45-P	€ 388,00	77-4-45-T	€ 422,00	77-4-45-C	€ 458,00
Swiveling gates - 5000 mm	73.0 kg	77-4-50-P	€ 405,00	77-4-50-T	€ 438,00	77-4-50-C	€ 475,00
Swiveling gates - 5500 mm	78.0 kg	77-4-55-P	€ 422,00	77-4-55-T	€ 455,00	77-4-55-C	€ 492,00
Swiveling gates - 6000 mm	83.0 kg	77-4-60-P	€ 438,00	77-4-60-T	€ 472,00	77-4-60-C	€ 509,00



These gates are Hot Dip Galvanized and red coated with red reflecting sticker,

Optionally available with: Base plate for plugging down

Note: Order also accepted with only color coated

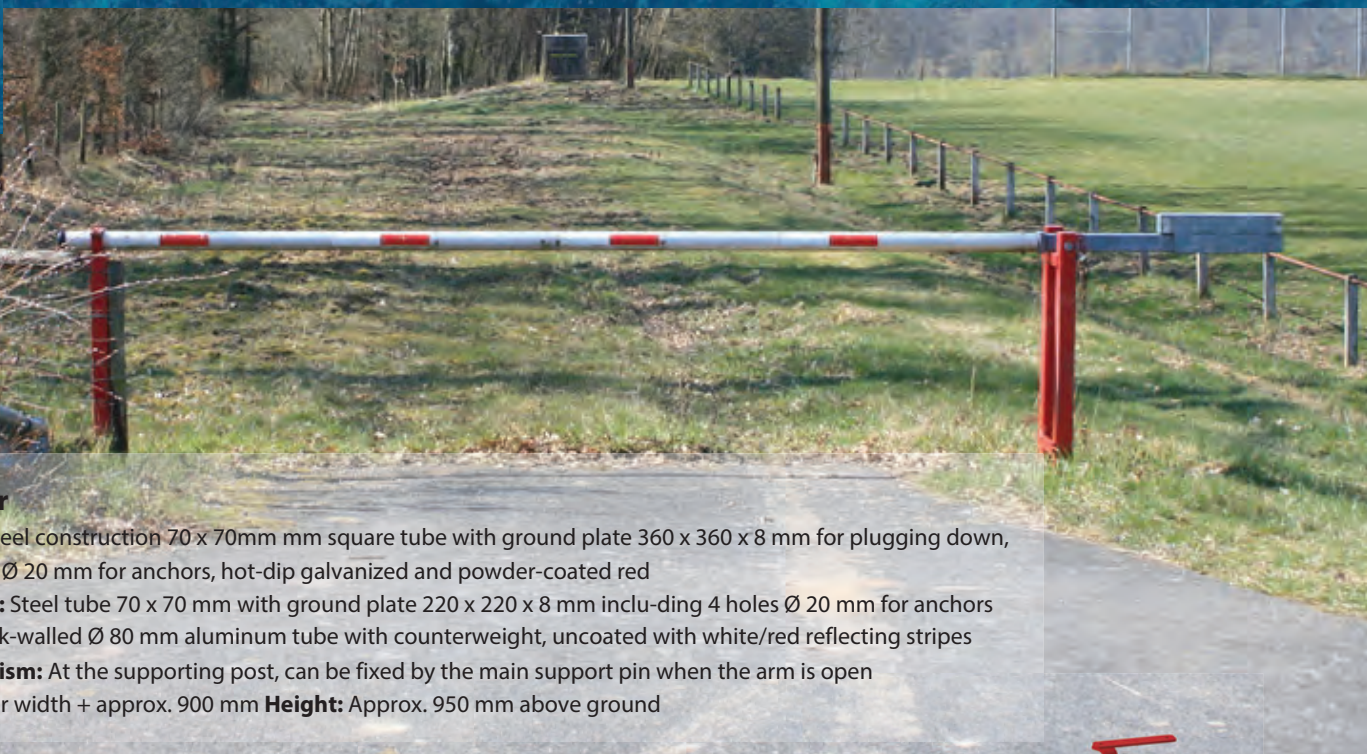

Access barrier

Main support: Steel construction 70 x 70mm mm square tube with ground plate 360 x 360 x 8 mm for plugging down, including 4 holes Ø 20 mm for anchors, hot-dip galvanized and powder-coated red

Supporting post: Steel tube 70 x 70 mm with ground plate 220 x 220 x 8 mm including 4 holes Ø 20 mm for anchors

Barrier arm: Thick-walled Ø 80 mm aluminum tube with counterweight, uncoated with white/red reflecting stripes

Locking mechanism: At the supporting post, can be fixed by the main support pin when the arm is open

Total width: Clear width + approx. 900 mm **Height:** Approx. 950 mm above ground

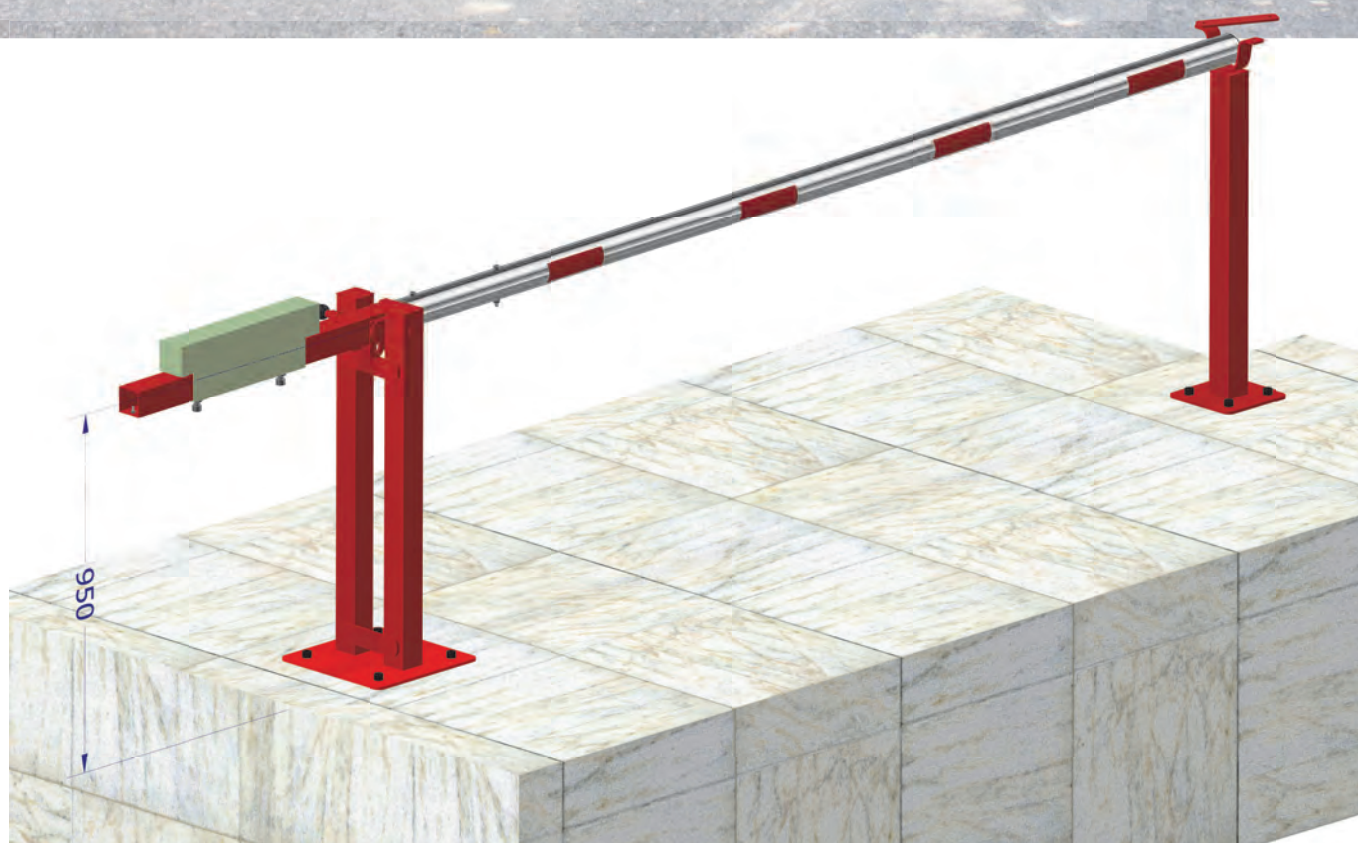

Padlock lock

Triangular lock

Euro cylinder lock

Article.	Weight.	Article no.	Price (DAP)	Article no.	Price (DAP)	Article no.	Price (DAP)
Swiveling gates - 3000 mm	50.0 kg	77-5-30-P	€ 375,00	77-5-30-T	€ 435,00	77-5-30-C	€ 448,00
Swiveling gates - 4000 mm	70.0 kg	77-5-40-P	€ 408,00	77-5-40-T	€ 469,00	77-5-40-C	€ 482,00
Swiveling gates - 5000 mm	90.0 kg	77-5-50-P	€ 442,00	77-5-50-T	€ 502,00	77-5-50-C	€ 515,00
Swiveling gates - 6000 mm	110.0 kg	77-5-60-P	€ 482,00	77-5-60-T	€ 538,00	77-5-60-C	€ 556,00
Swiveling gates - 7000 mm	125.0 kg	77-5-70-P	€ 529,00	77-5-70-T	€ 589,00	77-5-70-C	€ 603,00



These gates are Hot Dip Galvanized and red coated with red reflecting sticker,

Note: Order also accepted with only color coated



Access barrier

Main support: Steel construction 70 x 70mm mm square tube with ground plate 360 x 360 x 8 mm for plugging down, including 4 holes Ø 20 mm for anchors, hot-dip galvanized and powder-coated red

Supporting post: Aluminum tube with foot

Barrier arm: Thick-walled Ø 80 mm aluminum tube with counterweight, uncoated with white/red reflecting stripes

Locking mechanism: At the main support with a locking pin, for fixing the arm in open or closed position

Total width: Clear width + approx. 900 mm **Height:** Approx. 950 mm above ground

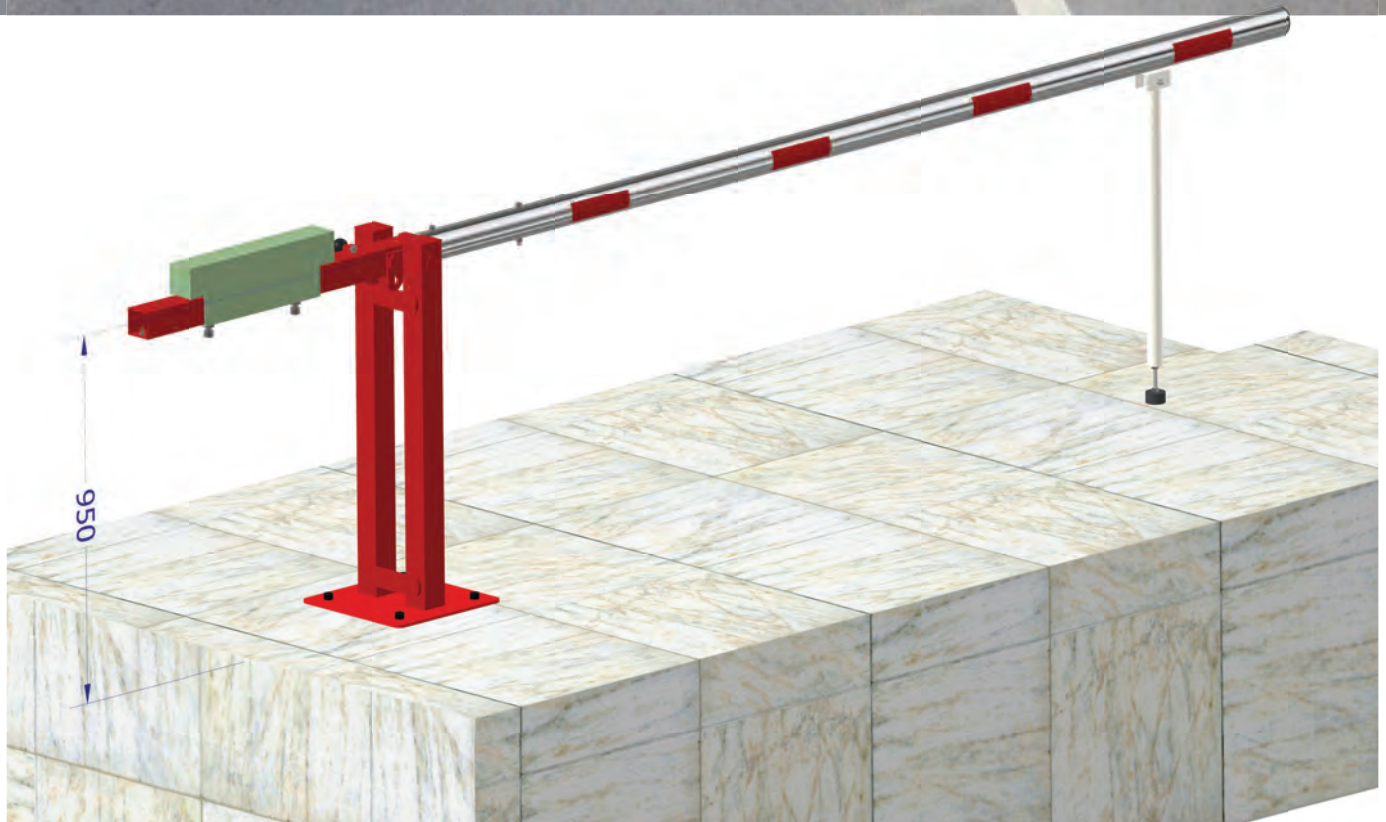

Article.	Weight.	Padlock lock		Triangular lock		Euro cylinder lock	
		Article no.	Price (DAP)	Article no.	Price (DAP)	Article no.	Price (DAP)
Swiveling gates - 3000 mm	50.0 kg	77-6-30-P	€ 381,00	77-6-30-T	€ 442,00	77-6-30-C	€ 455,00
Swiveling gates - 4000 mm	70.0 kg	77-6-40-P	€ 415,00	77-6-40-T	€ 475,00	77-6-40-C	€ 489,00
Swiveling gates - 5000 mm	90.0 kg	77-6-50-P	€ 448,00	77-6-50-T	€ 509,00	77-6-50-C	€ 522,00
Swiveling gates - 6000 mm	110.0 kg	77-6-60-P	€ 489,00	77-6-60-T	€ 549,00	77-6-60-C	€ 562,00
Swiveling gates - 7000 mm	125.0 kg	77-6-70-P	€ 536,00	77-6-70-T	€ 596,00	77-6-70-C	€ 609,00



These gates are Hot Dip Galvanized and red coated with red reflecting sticker,

Note: Order also accepted with only color coated

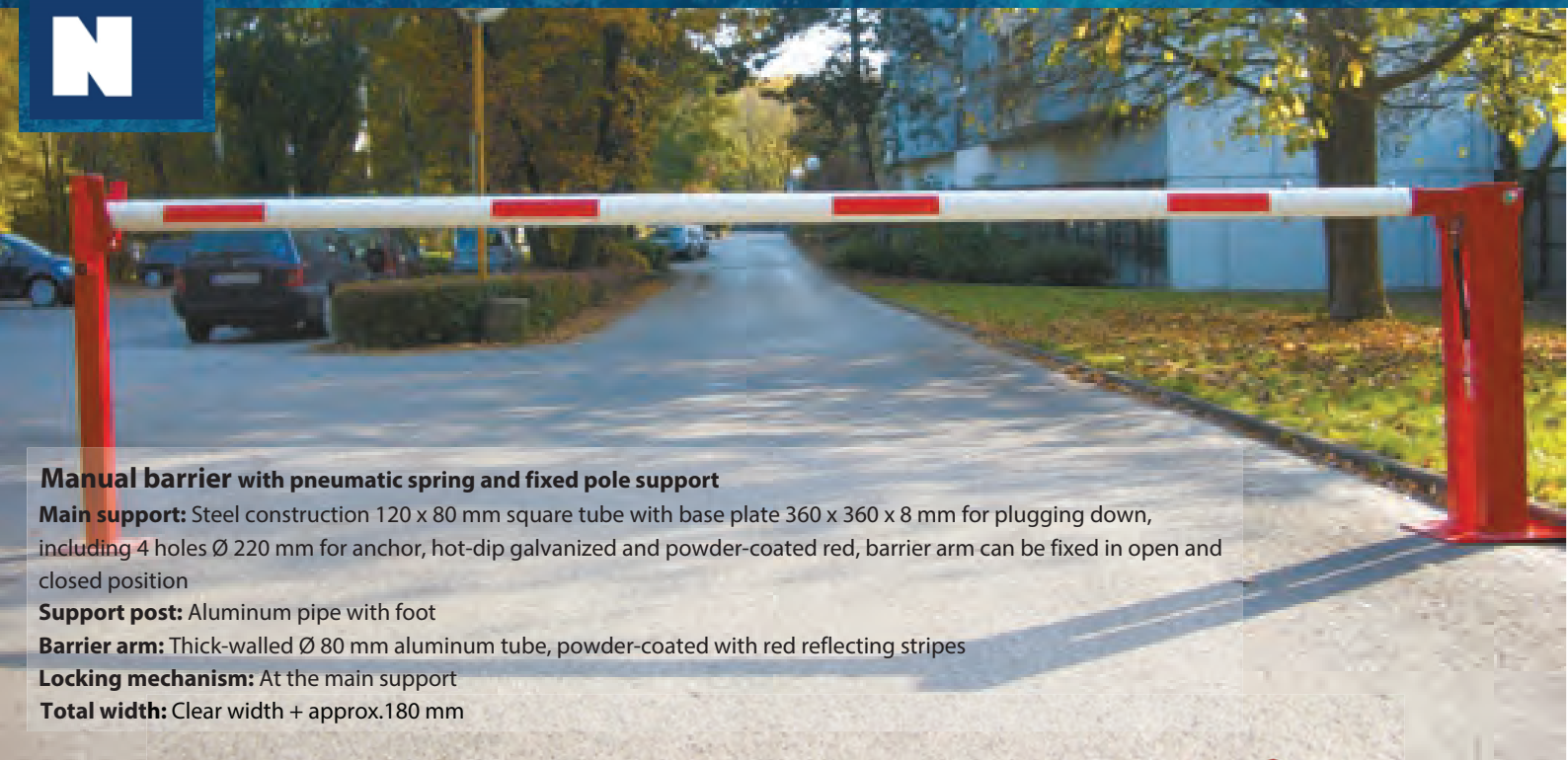

Manual barrier with pneumatic spring and fixed pole support

Main support: Steel construction 120 x 80 mm square tube with base plate 360 x 360 x 8 mm for plugging down, including 4 holes Ø 220 mm for anchor, hot-dip galvanized and powder-coated red, barrier arm can be fixed in open and closed position

Support post: Aluminum pipe with foot

Barrier arm: Thick-walled Ø 80 mm aluminum tube, powder-coated with red reflecting stripes

Locking mechanism: At the main support

Total width: Clear width + approx. 180 mm

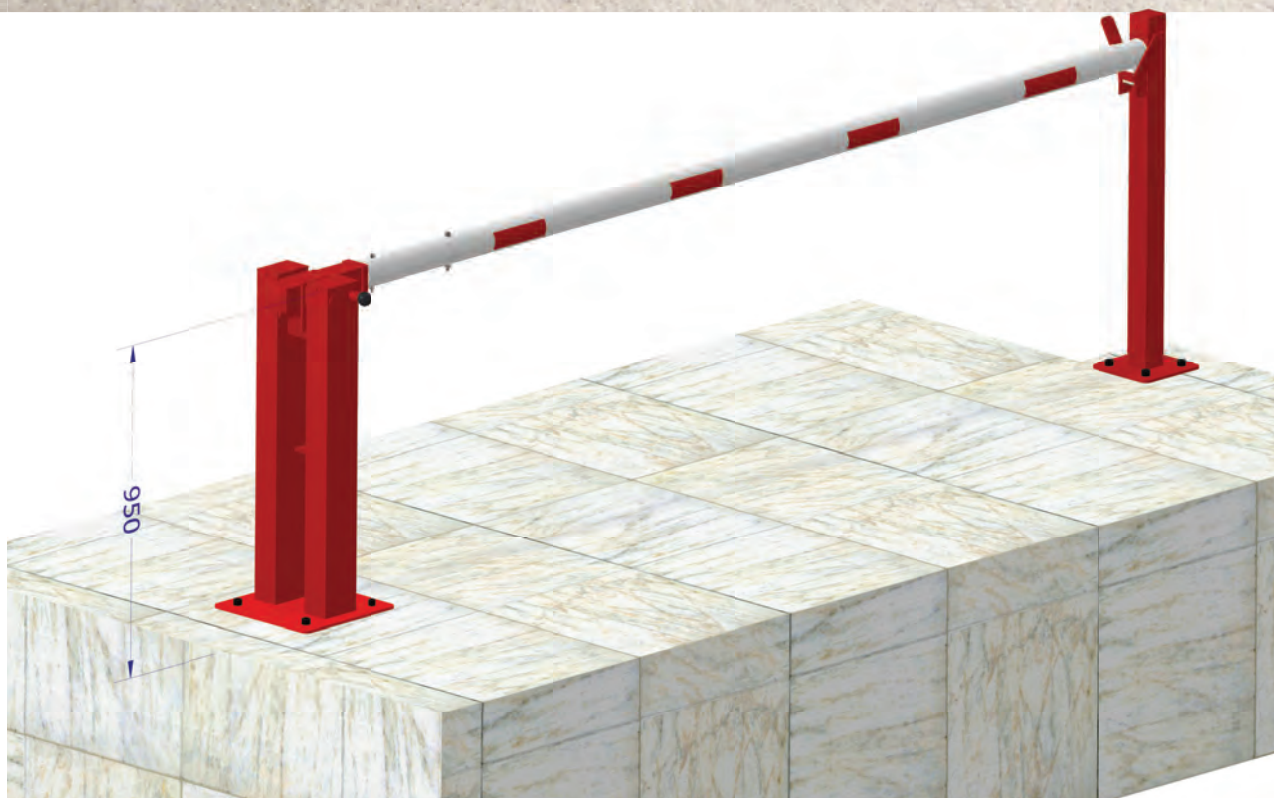

Padlock lock

Triangular lock

Euro cylinder lock

Article.	Weight.	Article no.	Price (DAP)	Article no.	Price (DAP)	Article no.	Price (DAP)
Swiveling gates - 3000 mm	45.0 kg	77-7-30-P	€ 502,00	77-7-30-T	€ 556,00	77-7-30-C	€ 582,00
Swiveling gates - 4000 mm	48.0 kg	77-7-40-P	€ 536,00	77-7-40-T	€ 589,00	77-7-40-C	€ 616,00
Swiveling gates - 5000 mm	51.0 kg	77-7-50-P	€ 569,00	77-7-50-T	€ 623,00	77-7-50-C	€ 649,00
Swiveling gates - 6000 mm	54.0 kg	77-7-60-P	€ 609,00	77-7-60-T	€ 663,00	77-7-60-C	€ 690,00
Swiveling gates - 7000 mm	58.0 kg	77-7-70-P	€ 656,00	77-7-70-T	€ 710,00	77-7-70-C	€ 737,00



These gates are Hot Dip Galvanized and red coated with red reflecting sticker,

Note: Order also accepted with only color coated



Manual barrier with pneumatic spring and fixed pole support

Main support: Steel construction 120 x 80 mm square tube with base plate 360 x 360 x 8 mm for plugging down, including 4 holes Ø 220 mm for anchor, hot-dip galvanized and powder-coated red, barrier arm can be fixed in open and closed position

Support post: Aluminum pipe with foot

Barrier arm: Thick-walled Ø 80 mm aluminum tube, powder-coated with red reflecting stripes

Locking mechanism: At the main support

Total width: Clear width + approx.180 mm

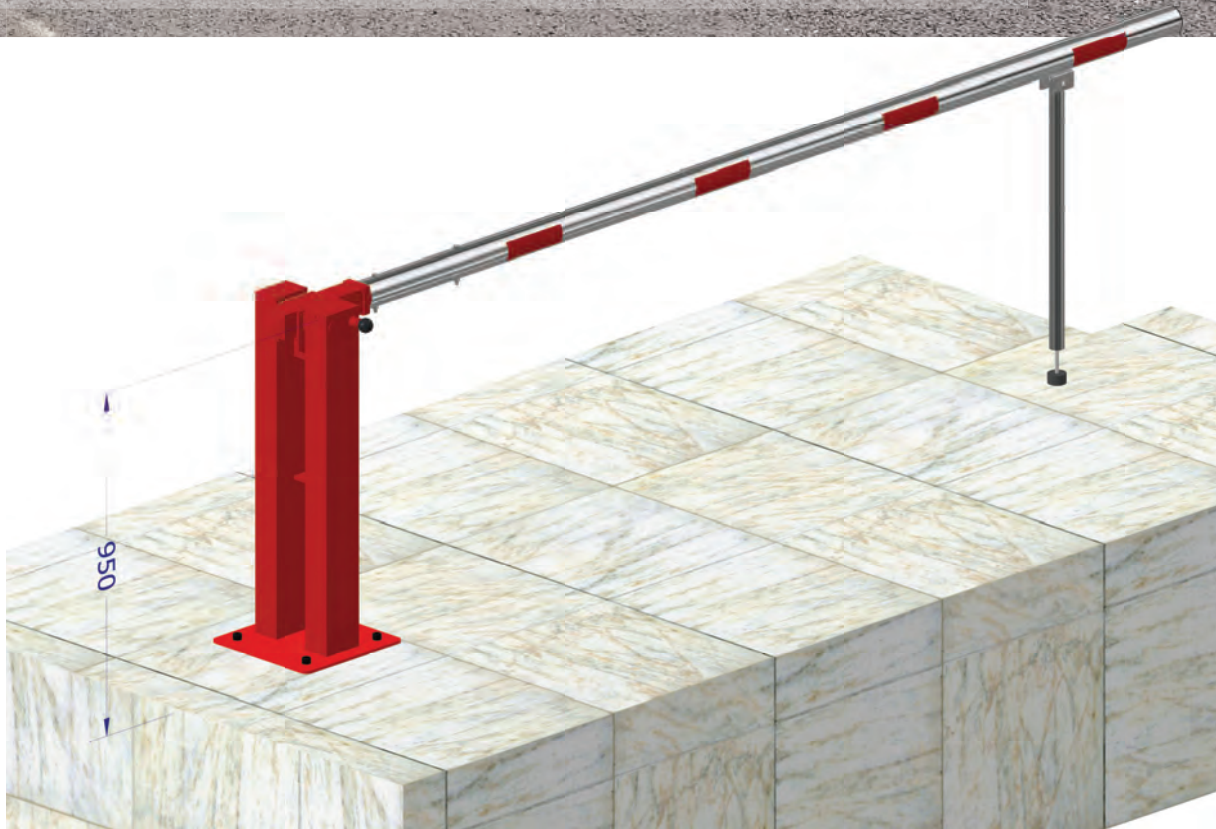

Article.	Weight.	Padlock lock		Triangular lock		Euro cylinder lock	
		Article no.	Price (DAP)	Article no.	Price (DAP)	Article no.	Price (DAP)
Swiveling gates - 3000 mm	41.0 kg	77-8-30-P	€ 522,00	77-8-30-T	€ 576,00	77-8-30-C	€ 582,00
Swiveling gates - 3500 mm	44.0 kg	77-8-35-P	€ 556,00	77-8-35-T	€ 609,00	77-8-35-C	€ 616,00
Swiveling gates - 4000 mm	47.0 kg	77-8-40-P	€ 589,00	77-8-40-T	€ 643,00	77-8-40-C	€ 649,00
Swiveling gates - 4500 mm	50.0 kg	77-8-45-P	€ 629,00	77-8-45-T	€ 683,00	77-8-45-C	€ 690,00
Swiveling gates - 5000 mm	54.0 kg	77-8-50-P	€ 676,00	77-8-55-T	€ 730,00	77-8-50-C	€ 737,00



These gates are Hot Dip Galvanized and red coated with red reflecting sticker,

Note: Order also accepted with only color coated



Swing barrier

Barrier can be swiveled horizontally, with two supporting posts. Locking mechanism closed or opened by locking pin fitted for a padlock or with triangular locking mechanism acc. to DIN 3223 or Euro profile cylinder lock.

Swiveling post: Steel tube Ø 102 mm

Barrier arm: Steel tube 60 x 40 mm

Supporting post: Steel tube 70 x 70 mm

Height: Approx. 1000 mm above ground

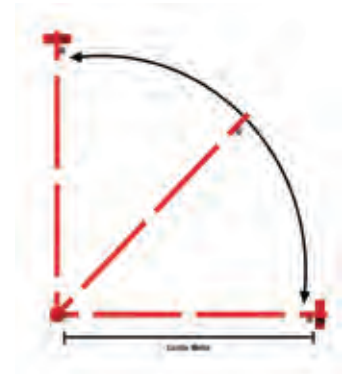
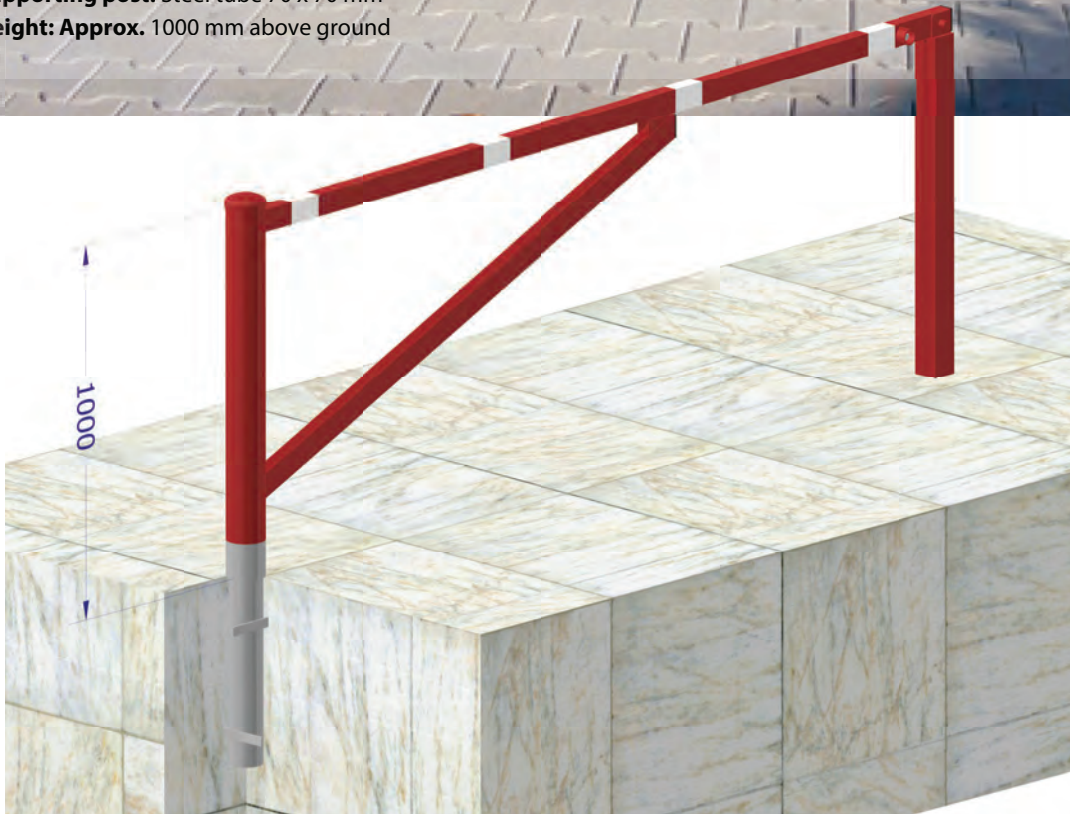

Article.	Weight.	Padlock lock		Triangular lock		Euro cylinder lock	
		Article no.	Price (DAP)	Article no.	Price (DAP)	Article no.	Price (DAP)
Swiveling gates - 2500 mm	39.0 kg	77-9-25-P	€ 288,00	77-9-25-T	€ 314,00	77-9-25-C	€ 348,00
Swiveling gates - 3000 mm	43.0 kg	77-9-30-P	€ 304,00	77-9-30-T	€ 331,00	77-9-30-C	€ 365,00
Swiveling gates - 3500 mm	47.0 kg	77-9-35-P	€ 321,00	77-9-35-T	€ 348,00	77-9-35-C	€ 381,00
Swiveling gates - 4000 mm	49.0 kg	77-9-40-P	€ 338,00	77-9-40-T	€ 365,00	77-9-40-C	€ 398,00
Swiveling gates - 4500 mm	51.0 kg	77-9-45-P	€ 355,00	77-9-45-T	€ 381,00	77-9-45-C	€ 415,00



These gates are Hot Dip Galvanized and red coated with white reflecting sticker
 Optionally available with: Base plate for plugging down, 360 x 360 x 8 mm including 4 holes Ø 21 mm hole pitch 260 x 260 mm
 Recommended foundation dimensions: width: 550 x 550 mm depth: 900 mm
 Note: Order also accepted with HDG



5. Outdoor equipment



5.1 Bicycle stands / lean-on hoops

65 - 74





Bicycle rack - Steady and space-saving due to alternating high and low racks. Racks can be bolted to form a serial system, with boreholes for anchoring or plugging.

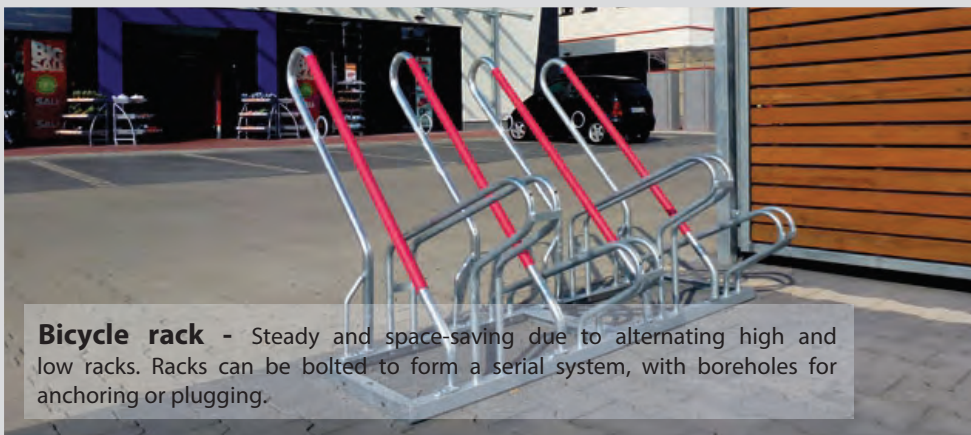
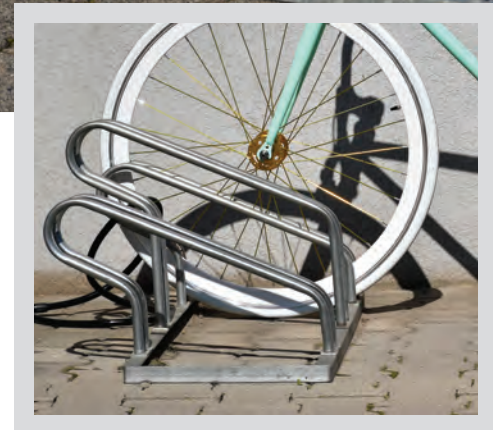

Bicycle rack - Steady and space-saving due to alternating high and low racks. Racks can be bolted to form a serial system, with boreholes for anchoring or plugging.

Article.

- Bicycle rack - one side for 3 bicycle, space between bicycle 350mm
- Bicycle rack - one side for 4 bicycle
- Bicycle rack - one side for 5 bicycle
- Bicycle rack - one side for 6 bicycle

- Bicycle rack - two side for 2 x 3 bicycle, space between bicycle 350mm
- Bicycle rack - two side for 2 x 5 bicycle
- Bicycle rack - two side for 2 x 6 bicycle

- Bicycle rack - one side for 3 bicycle, space between bicycle 350mm

Article no.

Article no.	Weight.	Price (DAP)
92-1-3	8.10 kg	€ 24,00
92-1-4	10.5 kg	€ 32,00
92-1-5	12.8 kg	€ 39,00
92-1-6	15.5 kg	€ 47,00
92-2-3	11.3 kg	€ 34,00
92-2-5	18.2 kg	€ 55,00
92-2-6	22.0 kg	€ 67,00
92-3-21	15.6 kg	€ 47,00



These rack are Hot Dip Galvanized Frame of angular section Hoop 19 mm round tube, approximate hight is 510 mm, Bicycle wheel width up to 55 mm. space between bicycles 350 mm

Note: Order also accepted with only color coated



Bicycle rack - Steady and weatherproof parking rack made of Ø 12 mm round steel with welded square tube 40 x 40 mm. Vertical tube can be fixed by bolts. Height approx. 500 mm above ground, for bicycle wheel width up to 55 mm, hot-dip galvanized



Bicycle rack fixed by casting in concrete, with 45° positioning



Bicycle rack fixed by wall brackets, with 45° positioning



Bicycle rack fixed by plugging down

Article.	Article no.	Weight.	Price (DAP)
Bicycle rack for six bicycle, for casting in concrete. (Angled positioning 45°)	92-4-1-6L	22.4 kg	€ 68,00
Bicycle rack for six bicycle, for casting in concrete. (Straight positioning 90°)	92-4-1-6S	22.0 kg	€ 67,00
Bicycle rack for six bicycle, for plugging down. (Angled positioning 45°)	92-4-2-6L	21.6 kg	€ 66,00
Bicycle rack for six bicycle, for plugging down. (Straight positioning 90°)	92-4-2-6S	21.1 kg	€ 64,00
Bicycle rack for six bicycle, for wall brackets. (Angled positioning 45°)	92-4-3-6L	19.4 kg	€ 59,00
Bicycle rack for six bicycle, for wall brackets. (Straight positioning 90°)	92-4-3-6S	19.1 kg	€ 58,00



Note: Order also accepted with only color coated



Bicycle rack - Steady and weatherproof parking rack made of Ø 12 mm round steel with welded square tube 40 x 40 mm. Vertical tube can be fixed by bolts. Height approx. 500 mm above ground, for bicycle wheel width up to 55 mm, hot-dip galvanized

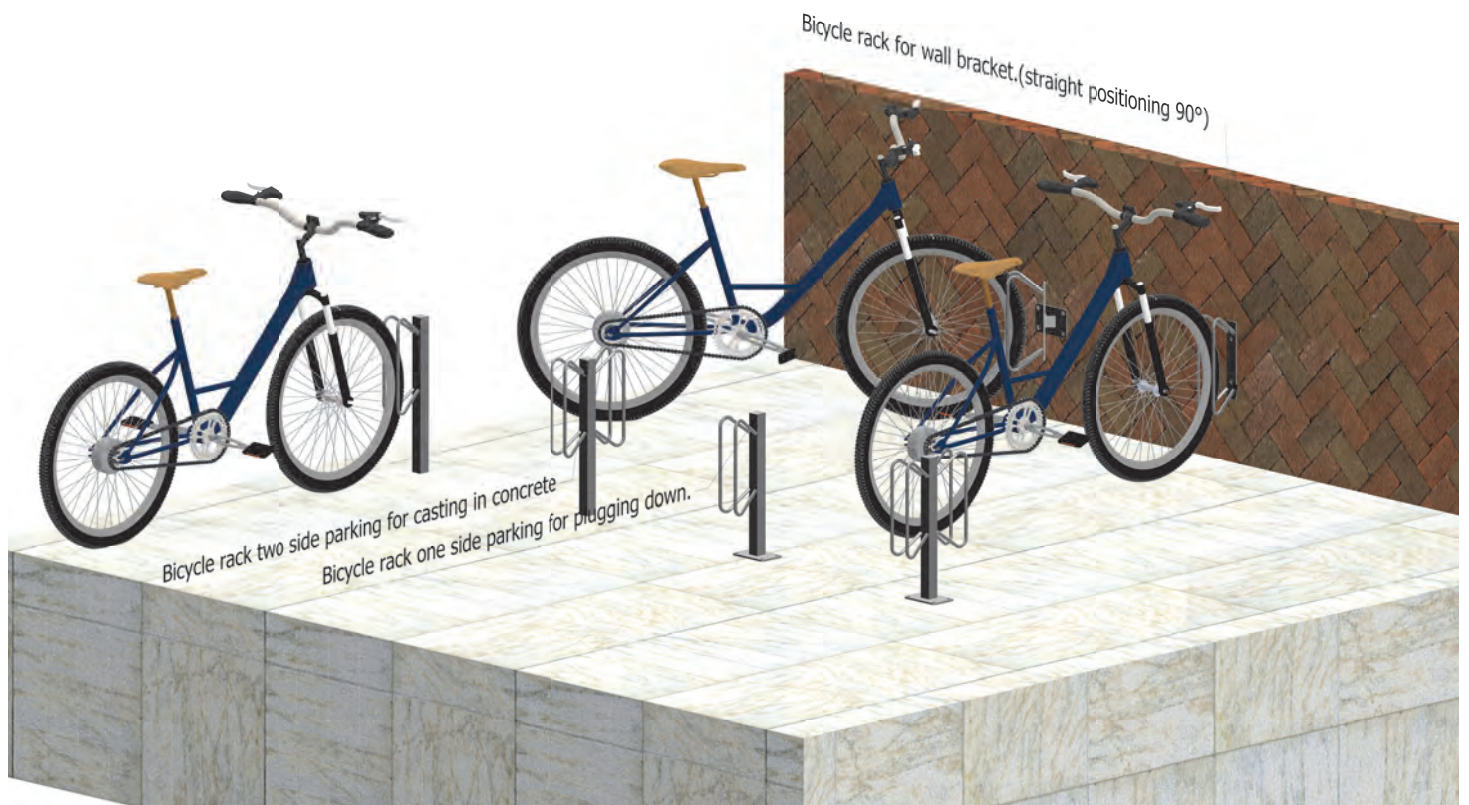

Article.

Bicycle rack one side parking, for casting in concrete.
 Bicycle rack two side parking, for casting in concrete.

Bicycle rack one side parking, for plugging down.
 Bicycle rack two side parking, for plugging down.

Bicycle rack for wall brackets. (Angled positioning 45°)
 Bicycle rack for wall brackets. (Straight positioning 90°)

Article no.

92-5-1S
 92-5-2S

92-6-1S
 92-6-2S

92-7-1L
 92-7-1S

Weight.

3.0 kg
 4.1 kg

3.0 kg
 4.1 kg

1.8 kg
 2.6 kg

Price (DAP)

€ 9,00
 € 12,00

€ 9,00
 € 12,00

€ 5,00
 € 7,00



Note: Order also accepted with only color coated



Article.

1. Bicycle individual - lean on hoop for casting in concrete
2. Bicycle individual - stand for plugging down (Single parking made of square tube)
3. Bicycle individual - lean on hoop for casting in concrete
4. Bicycle individual - stand for plugging down
5. Bicycle individual - stand for plugging down

Article no.

- 92-8
92-11
92-9
92-10
92-12

Weight.

- 10.0 kg
6.5 kg
9.4 kg
4.6 kg
6.0 kg

Price (DAP)

- € 30,00
€ 19,00
€ 28,00
€ 14,00
€ 18,00



Note: Order also accepted with only color coated

Bicycle lean on loop

N



Lean-on hoop made of steel tube - for casting in concrete, Hot-dip galvanized and optionally powder-coated in DB 703. total height: approx. 1200 mm

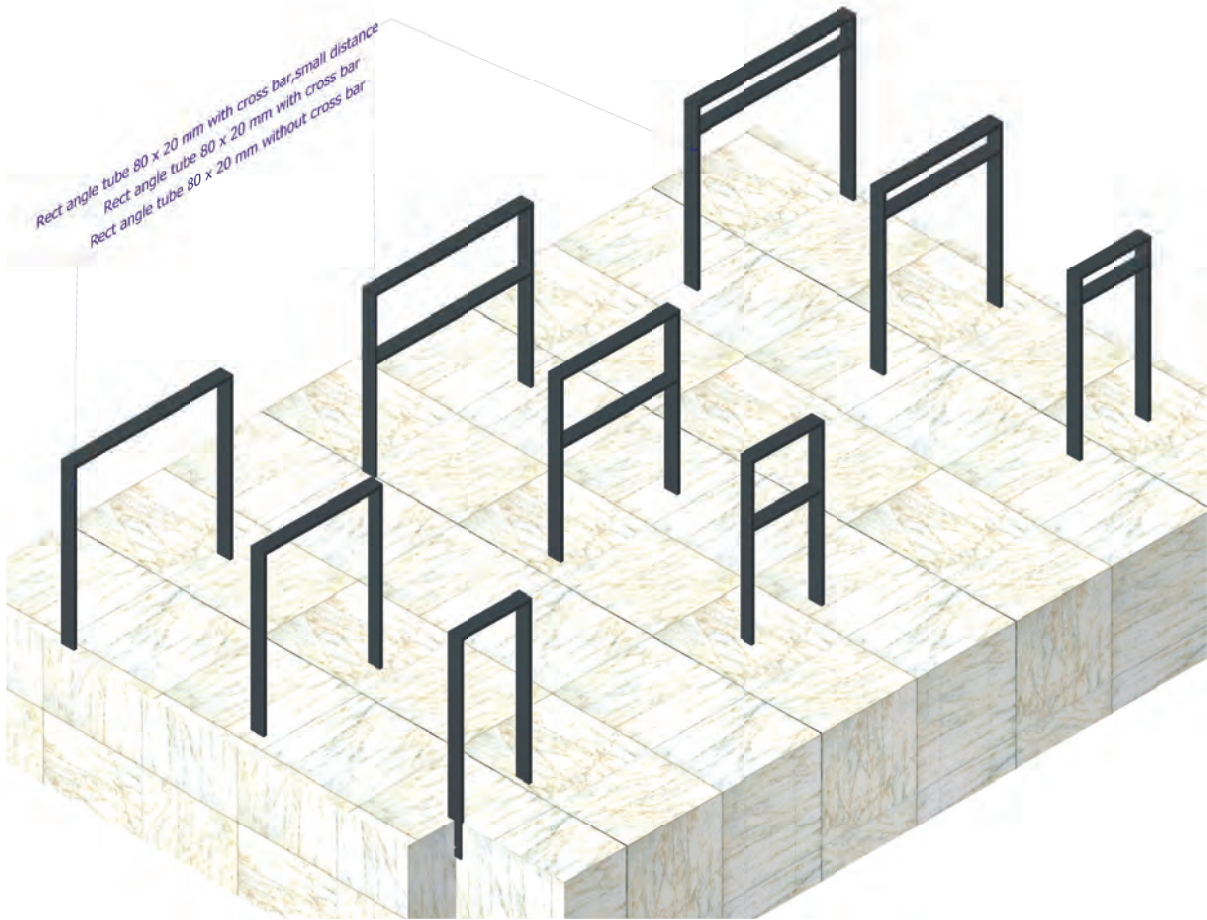

Article. Sq tube 80 x 20mm

Bicycle Loop, Height 1000mm x Width 450mm (without cross bar)
 Bicycle Loop, Height 1000mm x Width 750mm (without cross bar)
 Bicycle Loop, Height 1000mm x Width 1000mm (without cross bar)
 Bicycle Loop, Height 1000mm x Width 450mm (with cross bar)
 Bicycle Loop, Height 1000mm x Width 750mm (with cross bar)
 Bicycle Loop, Height 1000mm x Width 1000mm (with cross bar)
 Bicycle Loop, Height 1000mm x Width 450mm (without cross bar, small distance)
 Bicycle Loop, Height 1000mm x Width 750mm (without cross bar, small distance)
 Bicycle Loop, Height 1000mm x Width 1000mm (without cross bar, small distance)

Article no.

92-58-045
 92-58-075
 92-58-100
 92-59-045
 92-59-075
 92-59-100
 92-60-045
 92-60-075
 92-60-100

Weight. Price (DAP)

9.1 kg € 27,00
 10.0 kg € 30,00
 10.8 kg € 33,00
 10.3 kg € 31,00
 12.2 kg € 37,00
 13.9 kg € 42,00
 10.3 kg € 31,00
 12.2 kg € 37,00
 13.9 kg € 42,00



Lean-on hoop made of steel tube - for casting in concrete, Hot-dip galvanized and optionally powder-coated in DB 703. total height: approx. 1200 mm

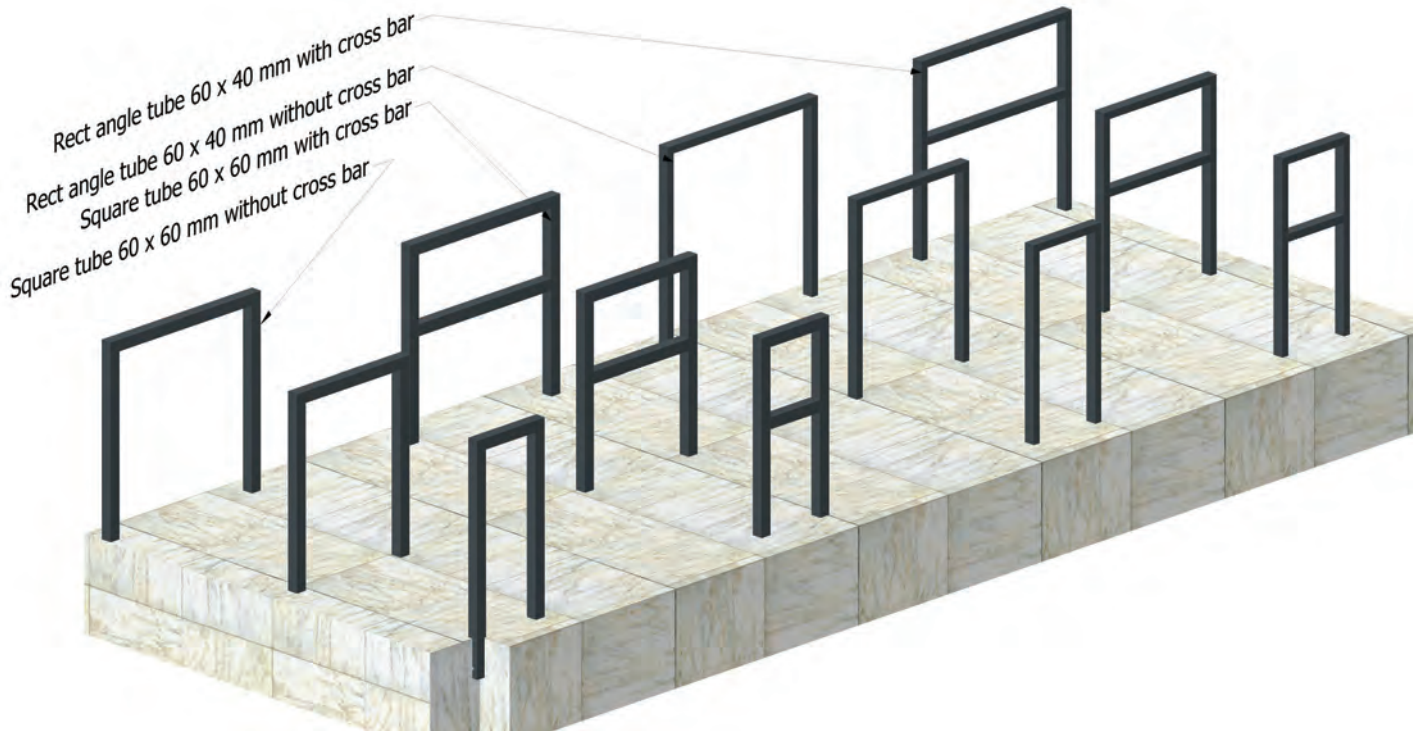

Article. Sq tube 60 x 60mm

- Bicycle Loop, Height 1000mm x Width 450mm (without cross bar)
- Bicycle Loop, Height 1000mm x Width 750mm (without cross bar)
- Bicycle Loop, Height 1000mm x Width 1000mm (without cross bar)
- Bicycle Loop, Height 1000mm x Width 450mm (with cross bar)
- Bicycle Loop, Height 1000mm x Width 750mm (with cross bar)
- Bicycle Loop, Height 1000mm x Width 1000mm (with cross bar)

Article. Sq tube 60 x 40mm

- Bicycle Loop, Height 1000mm x Width 450mm (without cross bar)
- Bicycle Loop, Height 1000mm x Width 750mm (without cross bar)
- Bicycle Loop, Height 1000mm x Width 1000mm (without cross bar)
- Bicycle Loop, Height 1000mm x Width 450mm (with cross bar)
- Bicycle Loop, Height 1000mm x Width 750mm (with cross bar)
- Bicycle Loop, Height 1000mm x Width 1000mm (with cross bar)

Article no.

- 92-61-045
- 92-61-075
- 92-61-100
- 92-62-045
- 92-62-075
- 92-62-100

Weight.

- 10.5 kg
- 11.7 kg
- 12.7 kg
- 11.8 kg
- 14.1 kg
- 16.0 kg

Price (DAP)

- € 32,00
- € 35,00
- € 38,00
- € 36,00
- € 43,00
- € 48,00

- 92-63-045
- 92-63-075
- 92-63-100
- 92-64-045
- 92-64-075
- 92-64-100

- 8.8 kg
- 9.8 kg
- 10.6 kg
- 10.0 kg
- 11.9 kg
- 13.5 kg

- € 26,00
- € 29,00
- € 32,00
- € 30,00
- € 36,00
- € 41,00



Lean-on hoop of flat bar steel - for casting in concrete, hot-dip galvanized and optionally powder-coated in RAL 7016 Total height approx. 1200 mm

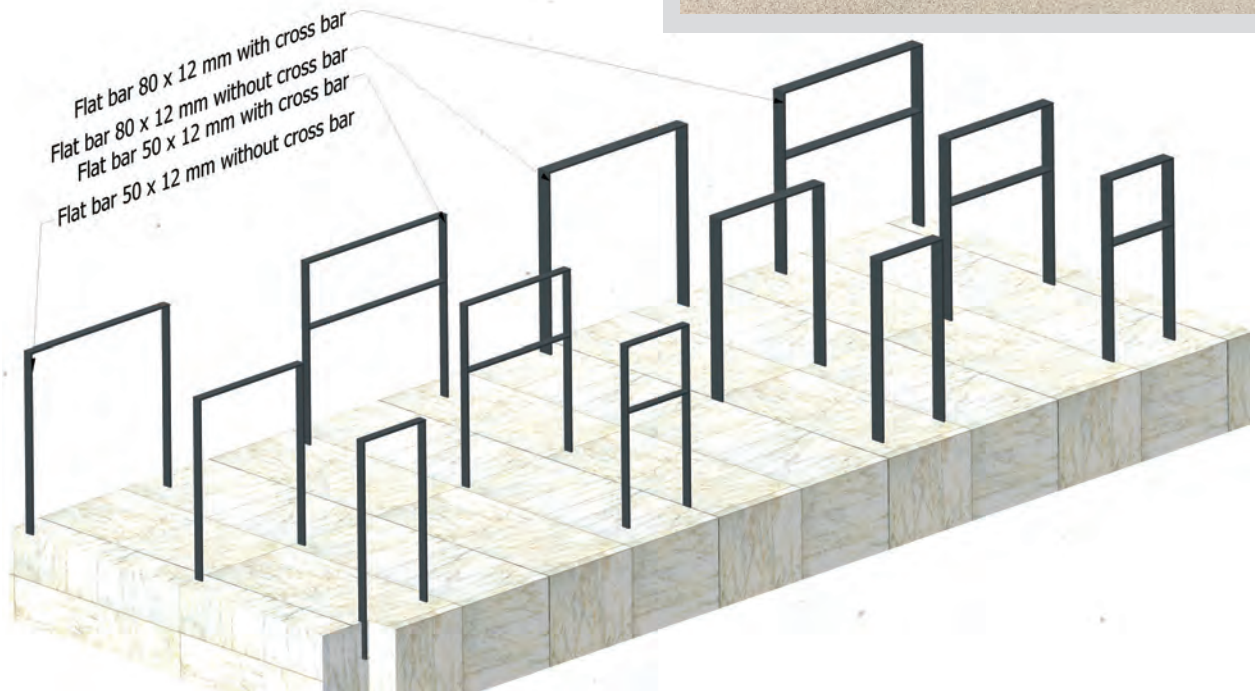

Article. Flat bar steel 50 x 12 mm

- Bicycle Loop, Height 1000mm x Width 450mm (without cross bar)
- Bicycle Loop, Height 1000mm x Width 750mm (without cross bar)
- Bicycle Loop, Height 1000mm x Width 1000mm (without cross bar)
- Bicycle Loop, Height 1000mm x Width 450mm (with cross bar)
- Bicycle Loop, Height 1000mm x Width 750mm (with cross bar)
- Bicycle Loop, Height 1000mm x Width 1000mm (with cross bar)

Article no.

- 92-65-045
- 92-65-075
- 92-65-100
- 92-66-045
- 92-66-075
- 92-66-100

Weight.

- 14.1 kg
- 15.6 kg
- 16.9 kg
- 16.3 kg
- 19.3 kg
- 21.8 kg

Price (DAP)

- € 43,00
- € 47,00
- € 51,00
- € 49,00
- € 59,00
- € 66,00

Article. Flat bar steel 80 x 12 mm

- Bicycle Loop, Height 1000mm x Width 450mm (without cross bar)
- Bicycle Loop, Height 1000mm x Width 750mm (without cross bar)
- Bicycle Loop, Height 1000mm x Width 1000mm (without cross bar)
- Bicycle Loop, Height 1000mm x Width 450mm (with cross bar)
- Bicycle Loop, Height 1000mm x Width 750mm (with cross bar)
- Bicycle Loop, Height 1000mm x Width 1000mm (with cross bar)

- 92-67-045
- 92-67-075
- 92-67-100
- 92-68-045
- 92-68-075
- 92-68-100

- 22.6 kg
- 25.1 kg
- 27.0 kg
- 26.0 kg
- 30.8 kg
- 34.8 kg

- € 69,00
- € 76,00
- € 82,00
- € 79,00
- € 94,00
- € 106,00

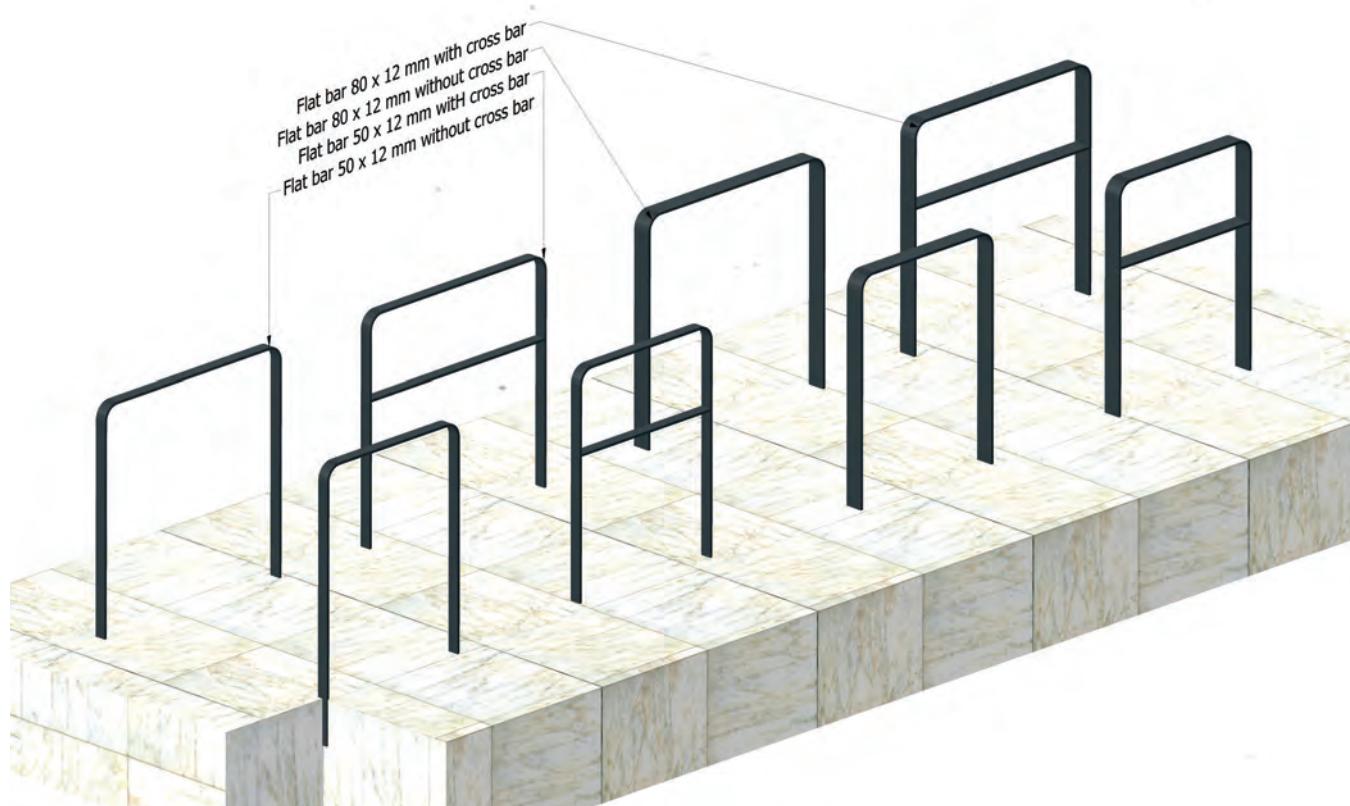

Article. Flat bar steel 50 x 12 mm

- Bicycle Loop, Height 1000mm x Width 750mm (without cross bar)
- Bicycle Loop, Height 1000mm x Width 1000mm (without cross bar)
- Bicycle Loop, Height 1000mm x Width 750mm (with cross bar)
- Bicycle Loop, Height 1000mm x Width 1000mm (with cross bar)

Article no.

- 92-69-075
- 92-69-100
- 92-70-075
- 92-70-100

Weight.

- 15.4 kg
- 16.7 kg
- 19.0 kg
- 21.0 kg

Price (DAP)

- € 47,00
- € 51,00
- € 58,00
- € 64,00

Article. Flat bar steel 80 x 12 mm

- Bicycle Loop, Height 1000mm x Width 750mm (without cross bar)
- Bicycle Loop, Height 1000mm x Width 1000mm (without cross bar)
- Bicycle Loop, Height 1000mm x Width 750mm (with cross bar)
- Bicycle Loop, Height 1000mm x Width 1000mm (with cross bar)

- 92-71-075
- 92-71-100
- 92-72-075
- 92-72-100

- 24.6 kg
- 26.7 kg
- 30.4 kg
- 34.4 kg

- € 75,00
- € 81,00
- € 93,00
- € 105,00



Bicycle parking rack - With guide rails for screwing on hoops
height: 800mm, hoop spacing: 700mm. hot-dip galvanized

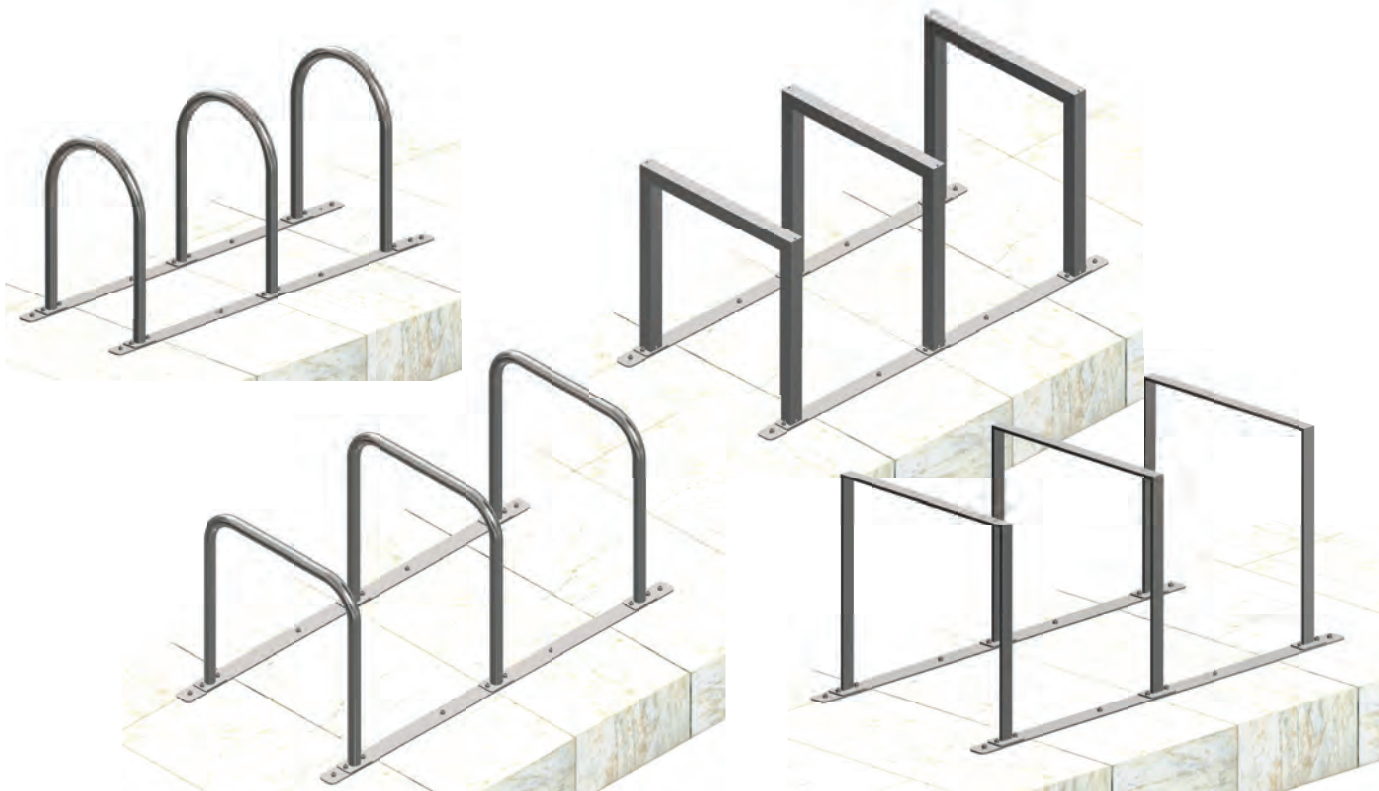

Article. Round hoop of steel tube Ø 48 mm, width 460 mm

- Bicycle hoop, Height 800mm x 1400mm. Space 700 mm (For 2 bicycles)
- Bicycle hoop, Height 800mm x 2100mm. Space 700 mm (For 3 bicycles)
- Bicycle hoop, Height 800mm x 2800mm. Space 700 mm (For 4 bicycles)

Article no.

- 92-23-20
- 92-23-30
- 92-23-40

Weight.

- 20.5 kg
- 30.5 kg
- 40.5 kg

Price (DAP)

- € 62,00
- € 92,00
- € 123,00

Article. Hoop of steel tube Ø 48 mm width: 800 mm

- Bicycle hoop, Height 800mm x 1400mm. Space 700 mm (For 2 bicycles)
- Bicycle hoop, Height 800mm x 2100mm. Space 700 mm (For 3 bicycles)
- Bicycle hoop, Height 800mm x 2800mm. Space 700 mm (For 4 bicycles)

- 92-24-20
- 92-24-30
- 92-24-40

- 22.5 kg
- 34.0 kg
- 45.0 kg

- € 68,00
- € 103,00
- € 137,00

Article. Hoop of steel tube 60 x 60 mm width: 800 mm

- Bicycle hoop, Height 800mm x 1400mm. Space 700 mm (For 2 bicycles)
- Bicycle hoop, Height 800mm x 2100mm. Space 700 mm (For 3 bicycles)
- Bicycle hoop, Height 800mm x 2800mm. Space 700 mm (For 4 bicycles)

- 92-25-20
- 92-25-30
- 92-25-40

- 26.5 kg
- 40.0 kg
- 53.5 kg

- € 80,00
- € 121,00
- € 163,00

Article. Hoop of flat steel 50 x 12 mm width: 800 mm

- Bicycle hoop, Height 800mm x 1400mm. Space 700 mm (For 2 bicycles)
- Bicycle hoop, Height 800mm x 2100mm. Space 700 mm (For 3 bicycles)
- Bicycle hoop, Height 800mm x 2800mm. Space 700 mm (For 4 bicycles)

- 92-26-20
- 92-26-30
- 92-26-40

- 32.5 kg
- 49.0 kg
- 65.0 kg

- € 99,00
- € 149,00
- € 198,00



Bicycle parking rack - Easy parking of bicycles, theft proof locking, simple installation, high stability

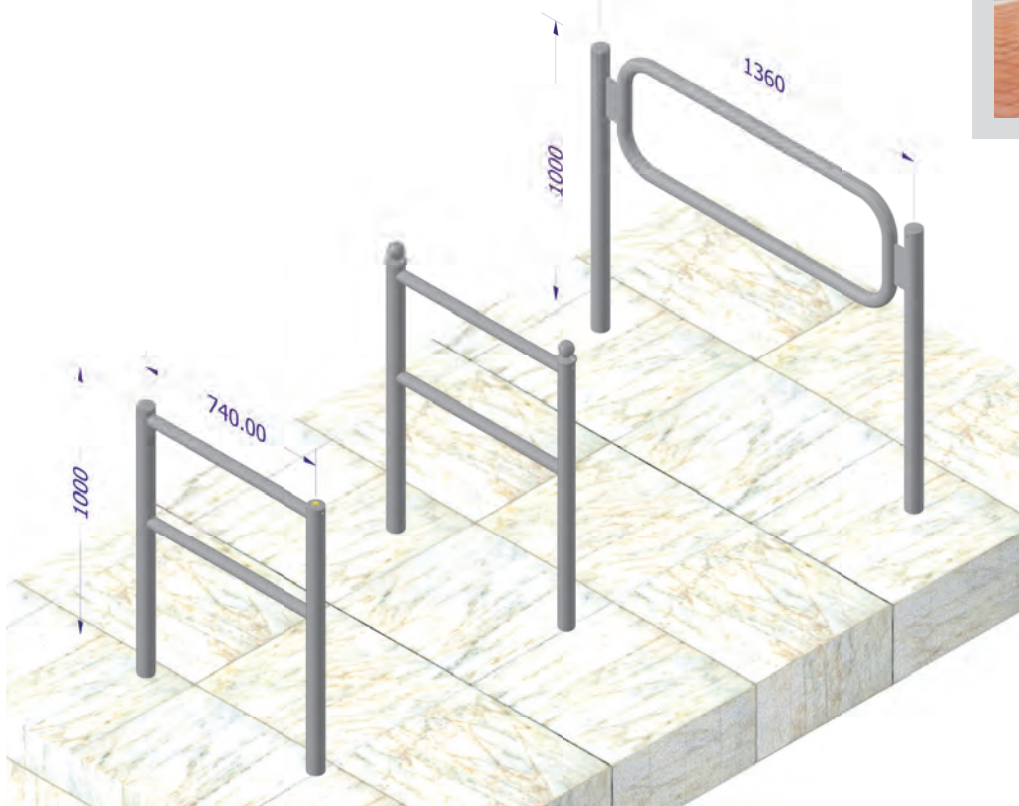

Bicycle Lean-on hoop

Article no - 99-82-803

vertical steel tubes \varnothing 60 mm
tubular frame \varnothing 48 mm
total length approx. 1425 mm
height above ground approx. 900 mm

Bicycle lean-on hoop

Article no - 99-82-801 & 99-82-802

vertical steel tube \varnothing 60 x 2.5 mm
with cross tubes \varnothing 42 x 2.5 mm
total length 800 mm
height above ground approx. 1300 mm

Article.

1. Bicycle individual - with flat head lean on hoop for casting in concrete
2. Bicycle individual - with ball head lean on hoop for casting in concrete
3. Bicycle individual - lean on hoop for casting in concrete

Article no.

99-82-801
99-82-802
99-82-803

Weight.

13.5 kg
13.6 kg
21.6 kg

Price (DAP)

€ 41,00
€ 41,00
€ 64,00

Know INDIA - Good Indian food is a ne Ābalance of flavors (salty, sweet, sour, bitter, hot) and textures... not too much of anything, chili included. Spices prevent our food from spoilage, and we are so much accustomed to eat spicy food. ... It is all because of bacteria and food borne pathogens: The chemical compounds of spices protect their plants as well as our food from food spoilage microbes and bacteria.





6. Work site protection



6.1 Barrier posts	77 - 80
6.2 Protective hoops	81 - 88
6.3 Protective railings	89 - 91
6.4 Crash guards	92



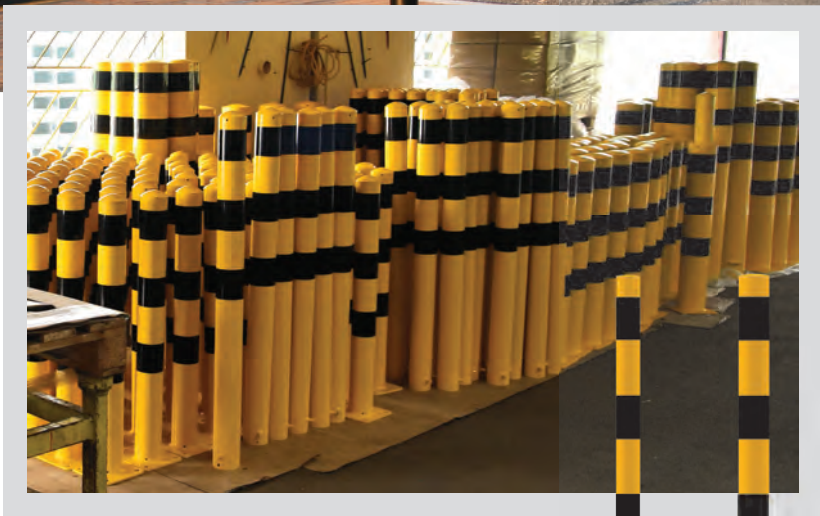

Industrial safety bollards - Protect people, buildings, assets and etc.



Article.

- Stationary Ø 60 x 2.6mm bollards for casting in concrete, above ground 900mm
- Stationary Ø 76 x 2.6mm bollards for casting in concrete, above ground 900mm
- Stationary Ø 101 x 3.0mm bollards for casting in concrete, above ground 900mm
- Stationary Ø 152 x 3.6mm bollards for casting in concrete, above ground 1200mm
- Stationary Ø 152 x 3.6mm bollards for casting in concrete, above ground 1500mm
- Stationary Ø 152 x 3.6mm bollards for casting in concrete, above ground 2000mm
- Stationary Ø 193 x 3.6mm bollards for casting in concrete, above ground 1200mm
- Stationary Ø 193 x 3.6mm bollards for casting in concrete, above ground 1500mm
- Stationary Ø 193 x 3.6mm bollards for casting in concrete, above ground 2000mm
- Stationary Ø 273 x 5mm bollards for casting in concrete, above ground 1500mm
- Stationary Ø 273 x 5mm bollards for casting in concrete, above ground 2000mm

Article no.

Article no.	Weight.	Price (DAP)
66-60-Typ1	5.3 kg	€ 16,00
66-76-Typ1	6.8 kg	€ 20,00
66-101-Typ1	10.4 kg	€ 31,00
66-152-Typ1-A	17.5 kg	€ 53,00
66-152-Typ1-B	21.6 kg	€ 66,00
66-152-Typ1-C	28.6 kg	€ 87,00
66-193-Typ1-A	22.4 kg	€ 68,00
66-193-Typ1-B	27.8 kg	€ 85,00
66-193-Typ1-C	36.7 kg	€ 112,00
66-273-Typ1-A	54.4 kg	€ 166,00
66-273-Typ1-B	72.0 kg	€ 220,00



These post are Hot Dip Galvanized and Signal yellow coated (RAL1003) with three 3M reflective Jet Black stripes (RAL 9005) furthermore order on customized size is accepted.

Note: Order also accepted with only Hot Dip Galvanizing

Bollards - Stationary to be fixed by plugs from Ø 60mm to Ø 273mm

N

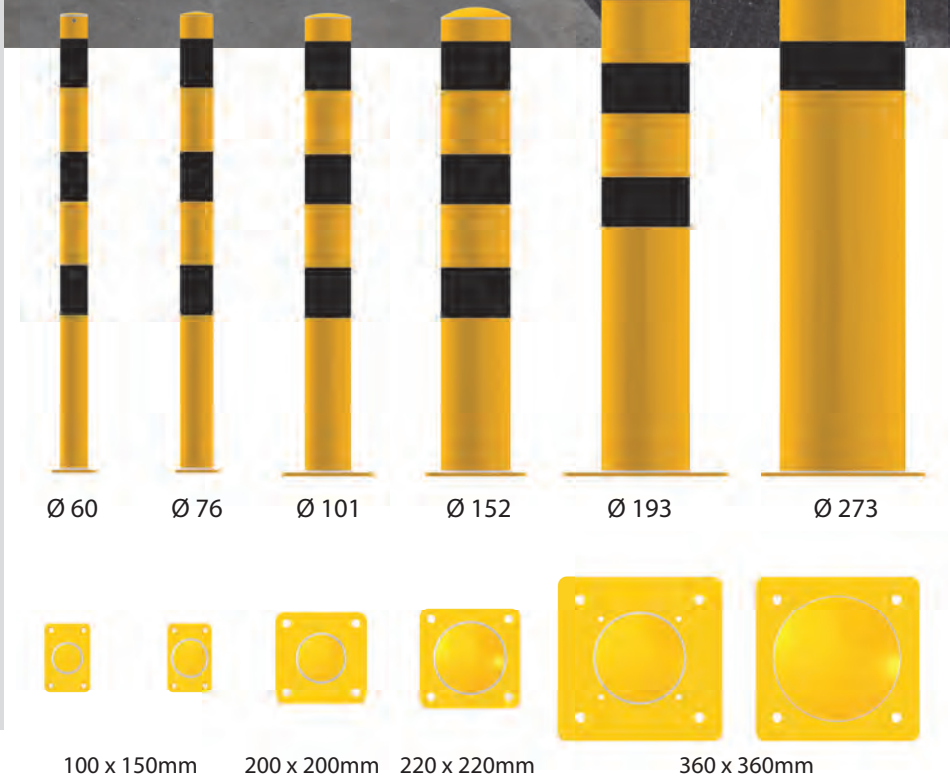

Article.

- Stationary Ø 60 x 2.6mm bollards to be fixed by plug, above ground 900mm
- Stationary Ø 76 x 2.6mm bollards to be fixed by plug, above ground 900mm
- Stationary Ø 101 x 3.0mm bollards to be fixed by plug, above ground 1000mm
- Stationary Ø 152 x 3.2mm bollards to be fixed by plug, above ground 1000mm
- Stationary Ø 152 x 3.2mm bollards to be fixed by plug, above ground 1500mm
- Stationary Ø 193 x 3.6mm bollards to be fixed by plug, above ground 1200mm
- Stationary Ø 193 x 3.6mm bollards to be fixed by plug, above ground 1500mm
- Stationary Ø 273 x 5.0mm bollards for be fixed by plug, above ground 1200mm
- Stationary Ø 273 x 5.0mm bollards for be fixed by plug, above ground 1500mm

Article no.

Article no.	Weight.	Price (DAP)
66-60-Typ2	4.7 kg	€ 14,00
66-76-Typ2	6.0 kg	€ 18,00
66-101-Typ2	10.5 kg	€ 32,00
66-152-Typ2-A	17.5 kg	€ 53,00
66-152-Typ2-B	22.3 kg	€ 68,00
66-193-Typ2-A	30.6 kg	€ 93,00
66-193-Typ2-B	35.9 kg	€ 110,00
66-273-Typ2-A	40.4 kg	€ 123,00
66-273-Typ2-B	62.5 kg	€ 191,00



These post are Hot Dip Galvanized and Signal yellow coated (RAL1003) with three 3M reflective Jet Black stripes (RAL 9005) furthermore order on customized size is accepted.

Note: Order also accepted with only Hot Dip Galvanizing

bollards with locking mechanism

bollards without locking mechanism



Ø 152



Ø 193



Ø 152



Ø 193



Article.

- Removable Ø 152 x 3.6mm bollards without locking mechanism, above ground 1500mm
- Removable Ø 152 x 3.6mm bollards without locking mechanism, above ground 2000mm
- Removable Ø 193 x 3.6mm bollards without locking mechanism, above ground 1500mm
- Removable Ø 193 x 3.6mm bollards without locking mechanism, above ground 2000mm
- Removable Ø 152 x 3.6mm bollards with triangular locking mechanism, above ground 1000mm
- Removable Ø 193 x 3.6mm bollards with triangular locking mechanism, above ground 1000mm

Article no.

- 66-152-Typ5-A
- 66-152-Typ5-B
- 66-193-Typ3-A
- 66-193-Typ3-B
- 66-152-Typ4
- 66-193-Typ4

Weight.

- 32.7 kg
- 39.7 kg
- 41.8 kg
- 50.8 kg
- 17.3 kg
- 23.3kg

Price (DAP)

- € 100,00
- € 121,00
- € 128,00
- € 155,00
- € 105,00
- € 142,00



These post are Hot Dip Galvanized and Signal yellow coated (RAL1003) with three 3M reflective Jet Black stripes (RAL 9005) furthermore order on customized size is accepted.

Note: Order also accepted with only Hot Dip Galvanizing

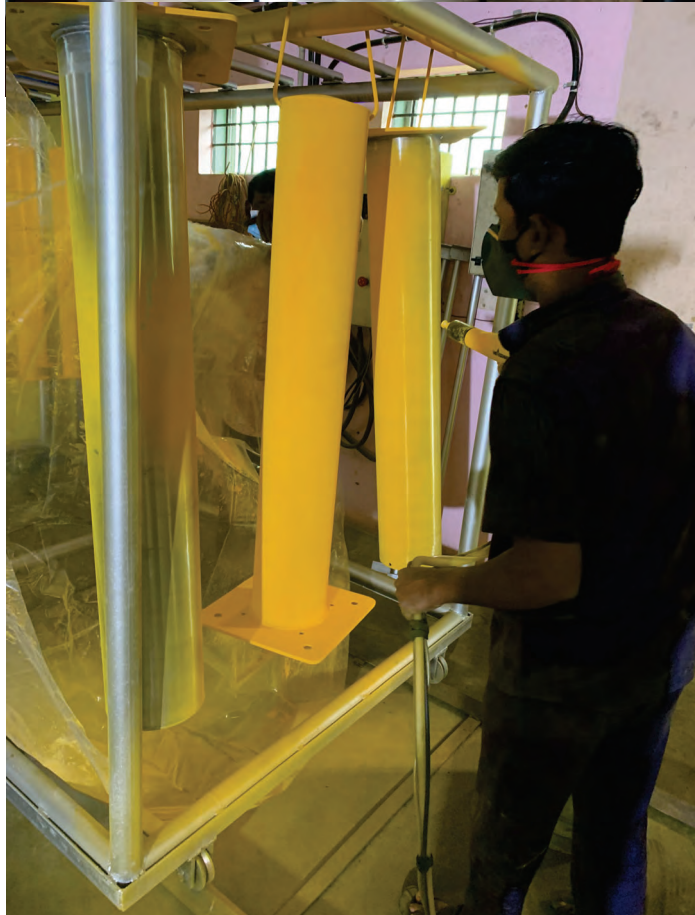

Bollards Hoop of Ø 48mm & Ø 60mm

N



Safety Hoop - Protection for entrance, ramps, separations, etc.

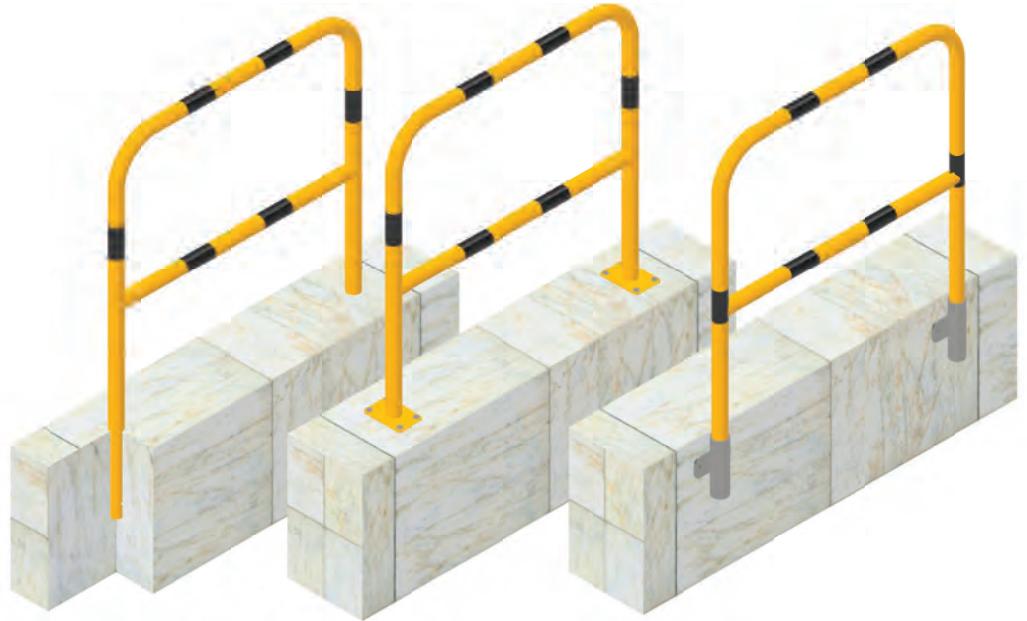

Article. for Casting in concrete

Barrier Loop Ø 48 x 2.6mm, Height 1000mm x Width 1000mm
 Barrier Loop Ø 48 x 2.6mm, Height 1000mm x Width 1500mm
 Barrier Loop Ø 48 x 2.6mm, Height 1000mm x Width 2000mm
 Barrier Loop Ø 60 x 2.6mm, Height 1000mm x Width 1000mm
 Barrier Loop Ø 60 x 2.6mm, Height 1000mm x Width 1500mm
 Barrier Loop Ø 60 x 2.6mm, Height 1000mm x Width 2000mm

Article. for Plugging down

Barrier Loop Ø 48 x 2.6mm, Height 1000mm x Width 1000mm
 Barrier Loop Ø 48 x 2.6mm, Height 1000mm x Width 1500mm
 Barrier Loop Ø 48 x 2.6mm, Height 1000mm x Width 2000mm
 Barrier Loop Ø 60 x 2.6mm, Height 1000mm x Width 1000mm
 Barrier Loop Ø 60 x 2.6mm, Height 1000mm x Width 1500mm
 Barrier Loop Ø 60 x 2.6mm, Height 1000mm x Width 2000mm

Article. for Wall mounting

Barrier Loop Ø 48 x 2.6mm, Height 1000mm x Width 700mm
 Barrier Loop Ø 48 x 2.6mm, Height 1000mm x Width 1000mm
 Barrier Loop Ø 48 x 2.6mm, Height 1000mm x Width 1200mm
 Barrier Loop Ø 60 x 2.6mm, Height 1000mm x Width 700mm
 Barrier Loop Ø 60 x 2.6mm, Height 1000mm x Width 1000mm
 Barrier Loop Ø 60 x 2.6mm, Height 1000mm x Width 1200mm

Article no.	Weight.	Price (DAP)
33-48-Typ1-1m	12.8 kg	€ 42,00
33-48-Typ1-1.5m	15.8 kg	€ 52,00
33-48-Typ1-2m	18.8 kg	€ 62,00
33-60-Typ1-1m	15.7 kg	€ 52,00
33-60-Typ1-1.5m	19.7 kg	€ 65,00
33-60-Typ1-2m	24.3 kg	€ 80,00
33-48-Typ2-1m	12.4 kg	€ 40,00
33-48-Typ2-1.5m	15.4 kg	€ 51,00
33-48-Typ2-2m	20.2 kg	€ 66,00
33-60-Typ2-1m	16.5 kg	€ 54,00
33-60-Typ2-1.5m	20.5 kg	€ 68,00
33-60-Typ2-2m	24.3 kg	€ 80,00
33-48-Typ3-0.7m	11.7 kg	€ 38,00
33-48-Typ3-1m	13.5 kg	€ 45,00
33-48-Typ3-1.2m	14.7 kg	€ 48,00
33-60-Typ3-0.7m	14.6 kg	€ 48,00
33-60-Typ3-1m	18.9 kg	€ 62,00
33-60-Typ3-1.2m	19.5 kg	€ 65,00



These post are Hot Dip Galvanized and Signal yellow coated (RAL1003) with 3M reflective Jet Black stripes (RAL 9005) furthermore order on customized size is accepted.

Note: Order also accepted with only Hot Dip Galvanizing



Safety Hoop - Effective protection for indoor and outdoor areas, warehouses and production halls. To secure work areas and traffic lanes, protect machines, columns and racks.

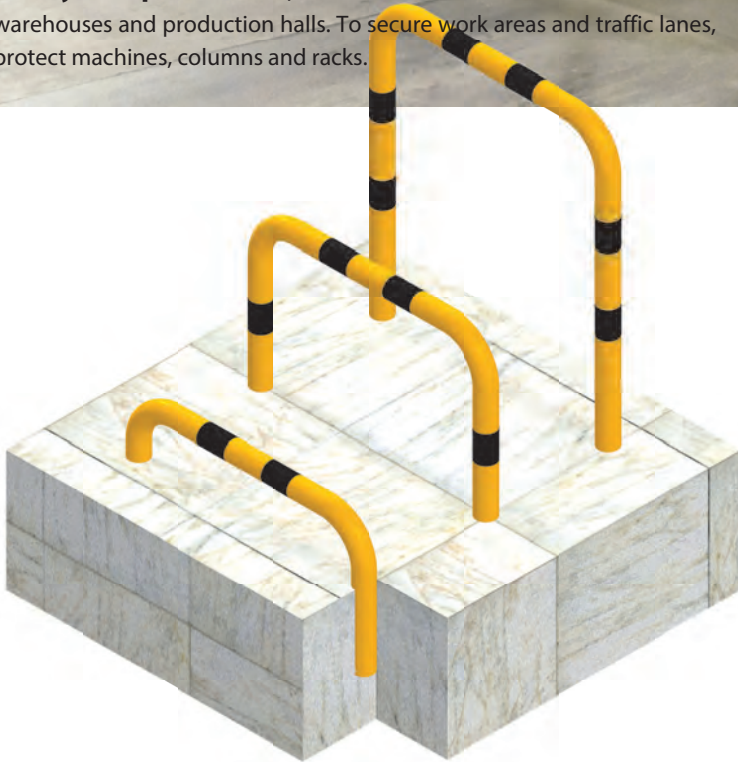

Article. for Casting in concrete

- Barrier Loop Ø 76 x 2.6mm, Height 250mm x Width 400mm
- Barrier Loop Ø 76 x 2.6mm, Height 250mm x Width 750mm
- Barrier Loop Ø 76 x 2.6mm, Height 250mm x Width 1000mm
- Barrier Loop Ø 76 x 2.6mm, Height 650mm x Width 400mm
- Barrier Loop Ø 76 x 2.6mm, Height 650mm x Width 750mm
- Barrier Loop Ø 76 x 2.6mm, Height 650mm x Width 1000mm
- Barrier Loop Ø 76 x 2.6mm, Height 1150mm x Width 400mm
- Barrier Loop Ø 76 x 2.6mm, Height 1150mm x Width 750mm
- Barrier Loop Ø 76 x 2.6mm, Height 1150mm x Width 1000mm

Article. for Plugging down

- Barrier Loop Ø 76 x 3mm, Height 250mm x Width 400mm
- Barrier Loop Ø 76 x 3mm, Height 250mm x Width 750mm
- Barrier Loop Ø 76 x 3mm, Height 250mm x Width 1000mm
- Barrier Loop Ø 76 x 3mm, Height 650mm x Width 400mm
- Barrier Loop Ø 76 x 3mm, Height 650mm x Width 750mm
- Barrier Loop Ø 76 x 3mm, Height 650mm x Width 1000mm
- Barrier Loop Ø 76 x 3mm, Height 1150mm x Width 400mm
- Barrier Loop Ø 76 x 3mm, Height 1150mm x Width 750mm
- Barrier Loop Ø 76 x 3mm, Height 1150mm x Width 1000mm

Article no.	Weight.	Price (DAP)
33-76-Typ1-A	6.2 kg	€ 20,00
33-76-Typ1-B	7.8 kg	€ 25,00
33-76-Typ1-C	9.1 kg	€ 30,00
33-76-Typ1-D	10.2 kg	€ 33,00
33-76-Typ1-E	11.8 kg	€ 39,00
33-76-Typ1-F	13.1 kg	€ 43,00
33-76-Typ1-G	15.2 kg	€ 50,00
33-76-Typ1-H	16.8 kg	€ 55,00
33-76-Typ1-I	18.1 kg	€ 60,00
33-76-Typ2-A	5.0 kg	€ 16,00
33-76-Typ2-B	6.8 kg	€ 22,00
33-76-Typ2-C	8.2 kg	€ 27,00
33-76-Typ2-D	9.5 kg	€ 31,00
33-76-Typ2-E	11.3 kg	€ 37,00
33-76-Typ2-F	12.7 kg	€ 42,00
33-76-Typ2-G	15.1 kg	€ 50,00
33-76-Typ2-H	16.8 kg	€ 55,00
33-76-Typ2-I	18.2 kg	€ 60,00



These post are Hot Dip Galvanized and Signal yellow coated (RAL1003) with 3M reflective Jet Black stripes (RAL 9005) furthermore order on customized size is accepted.

Note: Order also accepted with only Hot Dip Galvanizing

Bollards post and hoop with detachable

N



Safety Hoop - For temporary opening/closing of entrances. Locked with hexagon socket screws, the hoop can be detached from the plates and inserted as needed.

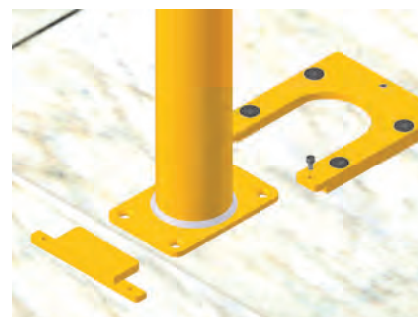
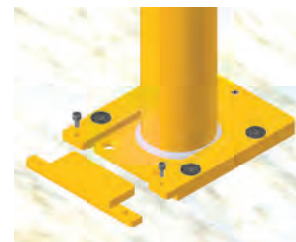
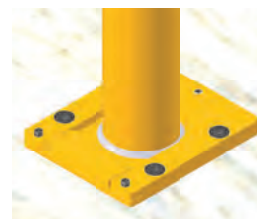

Article. Detachable barrier post for plugging down

Detachable $\varnothing 76 \times 2.6\text{mm}$ barrier post, above ground 1000mm

Detachable Sq. 70 x 70 x 2.6mm barrier post, above ground 1000mm

Article no.

66-76-Typ3

66-70-Typ3

Weight.

7.8 kg

7.9 kg

Price (DAP)

€ 26,00

€ 26,00

Article. Detachable anti-nudge hoop for plugging down

Detachable anti-nudge hoop $\varnothing 76 \times 3\text{mm}$, Height 650mm x Width 400mm

Detachable anti-nudge hoop $\varnothing 76 \times 3\text{mm}$, Height 650mm x Width 750mm

Detachable anti-nudge hoop $\varnothing 76 \times 3\text{mm}$, Height 650mm x Width 1000mm

Detachable anti-nudge hoop $\varnothing 76 \times 3\text{mm}$, Height 1150mm x Width 400mm

Detachable anti-nudge hoop $\varnothing 76 \times 3\text{mm}$, Height 1150mm x Width 750mm

Detachable anti-nudge hoop $\varnothing 76 \times 3\text{mm}$, Height 1150mm x Width 1000mm

33-76-Typ3-A

33-76-Typ3-B

33-76-Typ3-C

33-76-Typ3-D

33-76-Typ3-E

33-76-Typ3-F

13.3 kg

15.1 kg

16.5 kg

18.9 kg

20.7 kg

22.0 kg

€ 44,00

€ 50,00

€ 54,00

€ 62,00

€ 69,00

€ 73,00



These post are Hot Dip Galvanized and Signal yellow coated (RAL1003) with three 3M reflective Jet Black stripes (RAL 9005) furthermore order on customized size is accepted.

Note: Order also accepted with only Hot Dip Galvanizing

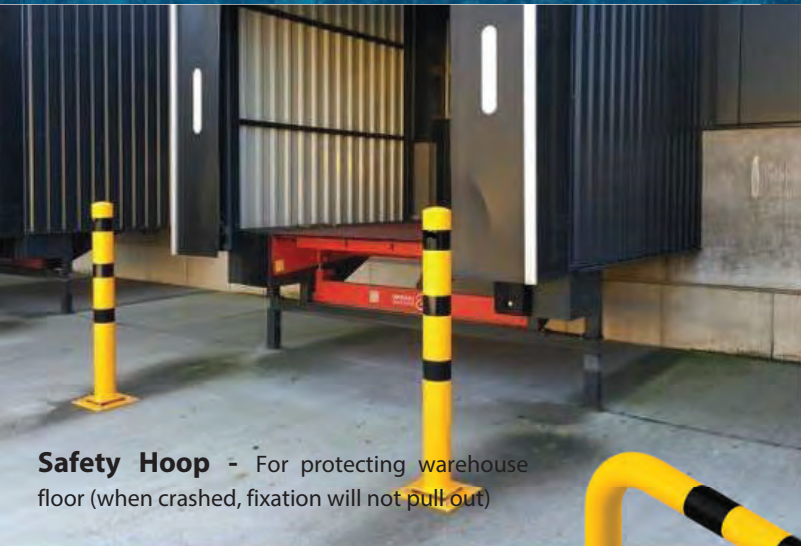

Safety Hoop - For protecting warehouse floor (when crashed, fixation will not pull-out)



Article. Impact resistance barrier post for plugging down

- Impact Ø 76 x 2.6mm barrier post, above ground 1000mm
- Impact Ø 152 x 3.6mm barrier post, above ground 1000mm
- Impact Sq. 70 x 70 x 2.6mm barrier post, above ground 1000mm

Article no.

- 66-76-Typ4
- 66-152-Typ3
- 66-70-Typ4

Weight.

- 9.2 kg
- 24.2 kg
- 9.3 kg

Price (DAP)

- € 31,00
- € 87,00
- € 32,00

Article. Impact resistance anti-nudge hoop for plugging down

- Impact anti-nudge hoop Ø 76 x 3mm, Height 650mm x Width 400mm
- Impact anti-nudge hoop Ø 76 x 3mm, Height 650mm x Width 750mm
- Impact anti-nudge hoop Ø 76 x 3mm, Height 650mm x Width 1000mm
- Impact anti-nudge hoop Ø 76 x 3mm, Height 1150mm x Width 400mm
- Impact anti-nudge hoop Ø 76 x 3mm, Height 1150mm x Width 750mm
- Impact anti-nudge hoop Ø 76 x 3mm, Height 1150mm x Width 1000mm

- 33-76-Typ4-A
- 33-76-Typ4-B
- 33-76-Typ4-C
- 33-76-Typ4-D
- 33-76-Typ4-E
- 33-76-Typ4-F

- 15.9 kg
- 17.7 kg
- 19.1 kg
- 21.5 kg
- 23.3 kg
- 25.3 kg

- € 52,00
- € 58,00
- € 63,00
- € 71,00
- € 77,00
- € 84,00



These post are Hot Dip Galvanized and Signal yellow coated (RAL1003) with three 3M reflective Jet Black stripes (RAL 9005) furthermore order on customized size is accepted.

Note: Order also accepted with only Hot Dip Galvanizing

Anti-nudge hoop Ø 76 mm

N



Anti-nudge hoop 90° single sided

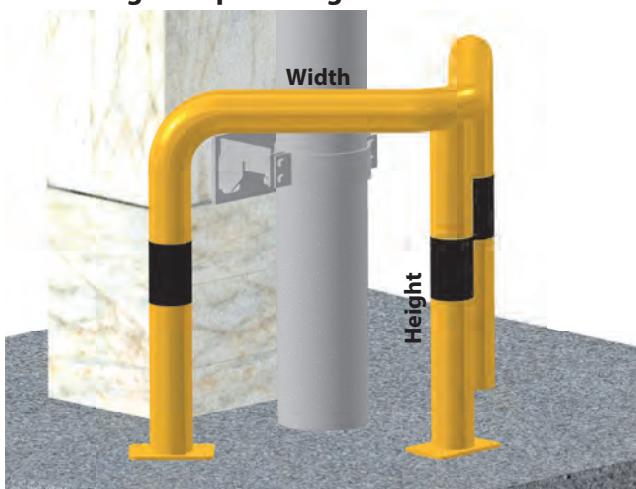

Anti-nudge hoop 90° double sided



Article. Anti-nudge hoop 90° single sided for casting in concrete

- Anti-nudge hoop Ø 76 x 3mm, Height 650mm x Width 400mm
- Anti-nudge hoop Ø 76 x 3mm, Height 1150mm x Width 400mm
- Anti-nudge hoop Ø 76 x 3mm, Height 650mm x Width 600mm
- Anti-nudge hoop Ø 76 x 3mm, Height 1150mm x Width 600mm

Article. Anti-nudge hoop 90° single sided for plugging down

- Anti-nudge hoop Ø 76 x 3mm, Height 650mm x Width 400mm
- Anti-nudge hoop Ø 76 x 3mm, Height 1150mm x Width 400mm
- Anti-nudge hoop Ø 76 x 3mm, Height 650mm x Width 600mm
- Anti-nudge hoop Ø 76 x 3mm, Height 1150mm x Width 600mm

Article. Anti-nudge hoop 90° double sided for casting in concrete

- Anti-nudge hoop Ø 76 x 3mm, Height 650mm x Length 400mm x Width 750mm
- Anti-nudge hoop Ø 76 x 3mm, Height 1150mm x Length 400mm x Width 750mm
- Anti-nudge hoop Ø 76 x 3mm, Height 650mm x Length 400mm x Width 1000mm
- Anti-nudge hoop Ø 76 x 3mm, Height 1150mm x Length 400mm x Width 1000mm

Article. Anti-nudge hoop 90° double sided for plugging down

- Anti-nudge hoop Ø 76 x 3mm, Height 650mm x Length 400mm x Width 750mm
- Anti-nudge hoop Ø 76 x 3mm, Height 1150mm x Length 400mm x Width 750mm
- Anti-nudge hoop Ø 76 x 3mm, Height 650mm x Length 400mm x Width 1000mm
- Anti-nudge hoop Ø 76 x 3mm, Height 1150mm x Length 400mm x Width 1000mm

Article no.	Weight.	Price (DAP)
67-3L-76-Typ1-A	19.0 kg	€ 63,00
67-3L-76-Typ1-B	25.0 kg	€ 82,00
67-3L-76-Typ1-C	22.0 kg	€ 72,00
67-3L-76-Typ1-D	27.5 kg	€ 91,00
67-3L-76-Typ2-A	15.2 kg	€ 50,00
67-3L-76-Typ2-B	23.5 kg	€ 78,00
67-3L-76-Typ2-C	17.3 kg	€ 57,00
67-3L-76-Typ2-D	25.6 kg	€ 85,00
67-4L-76-Typ1-A	28.5 kg	€ 94,00
67-4L-76-Typ1-B	36.0 kg	€ 119,00
67-4L-76-Typ1-C	30.0 kg	€ 100,00
67-4L-76-Typ1-D	37.5 kg	€ 124,00
67-4L-76-Typ2-A	22.1 kg	€ 73,00
67-4L-76-Typ2-B	33.3 kg	€ 110,00
67-4L-76-Typ2-C	25.8 kg	€ 85,00
67-4L-76-Typ2-D	36.9 kg	€ 131,00



These post are Hot Dip Galvanized and Signal yellow coated (RAL1003) with 3M reflective Jet Black stripes (RAL 9005) furthermore order on customized size is accepted.

Note: Order also accepted with only Hot Dip Galvanizing

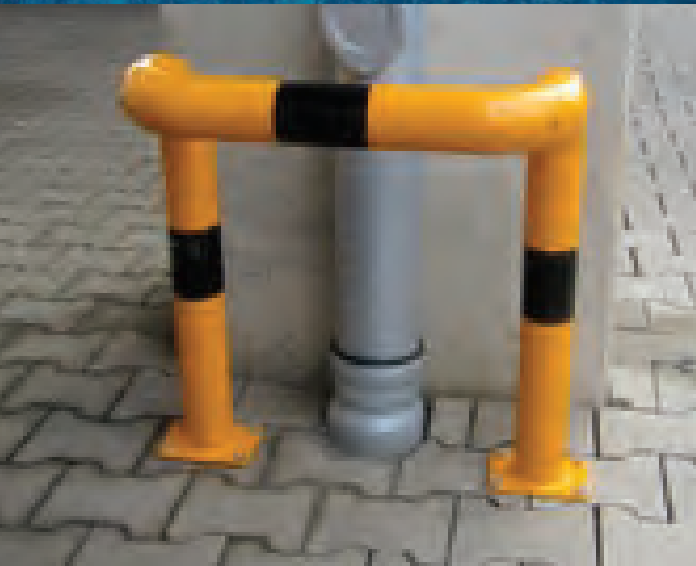

Anti-nudge hoop 90° single sided (deep)

Anti-nudge hoop 90° double sided (deep)

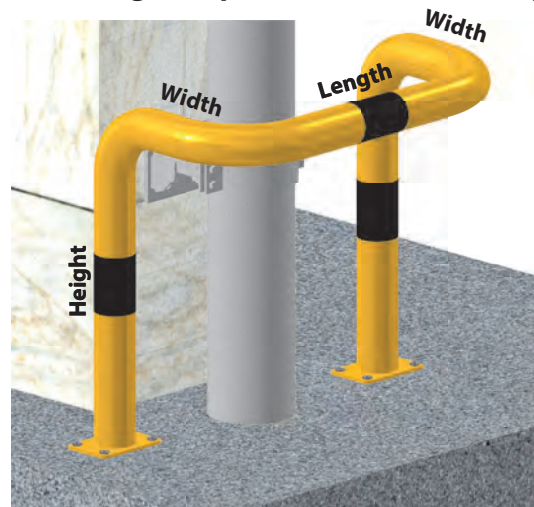
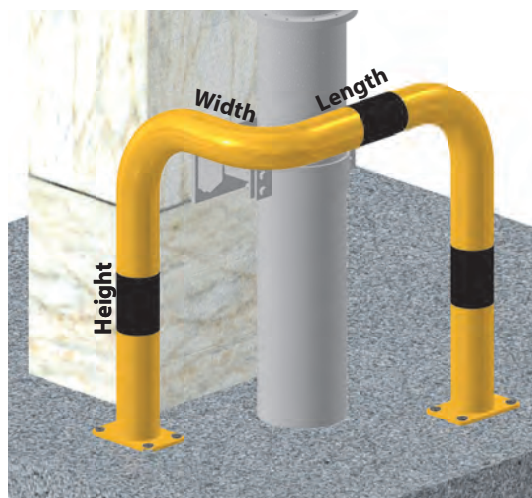

Article. Anti-nudge hoop 90° single sided for casting in concrete (Deep)

- Anti-nudge hoop Ø 76 x 3mm, Height 650mm x Length 400mm x Width 600mm (Right)
- Anti-nudge hoop Ø 76 x 3mm, Height 650mm x Length 400mm x Width 600mm (Left)
- Anti-nudge hoop Ø 76 x 3mm, Height 1150mm x Length 400mm x Width 600mm (Right)
- Anti-nudge hoop Ø 76 x 3mm, Height 1150mm x Length 400mm x Width 600mm (Left)

Article. Anti-nudge hoop 90° single sided for plugging down (Deep)

- Anti-nudge hoop Ø 76 x 3mm, Height 650mm x Length 400mm x Width 600mm (Right)
- Anti-nudge hoop Ø 76 x 3mm, Height 650mm x Length 400mm x Width 600mm (Left)
- Anti-nudge hoop Ø 76 x 3mm, Height 1150mm x Length 400mm x Width 600mm (Right)
- Anti-nudge hoop Ø 76 x 3mm, Height 1150mm x Length 400mm x Width 600mm (Left)

Article. Anti-nudge hoop 90° double sided for casting in concrete (Deep)

- Anti-nudge hoop Ø 76 x 3mm, Height 650mm x Length 400mm x Width 750mm
- Anti-nudge hoop Ø 76 x 3mm, Height 650mm x Length 400mm x Width 1000mm
- Anti-nudge hoop Ø 76 x 3mm, Height 1150mm x Length 400mm x Width 750mm
- Anti-nudge hoop Ø 76 x 3mm, Height 1150mm x Length 400mm x Width 1000mm

Article. Anti-nudge hoop 90° double sided for plugging down (Deep)

- Anti-nudge hoop Ø 76 x 3mm, Height 650mm x Length 400mm x Width 750mm
- Anti-nudge hoop Ø 76 x 3mm, Height 650mm x Length 400mm x Width 1000mm
- Anti-nudge hoop Ø 76 x 3mm, Height 1150mm x Length 400mm x Width 750mm
- Anti-nudge hoop Ø 76 x 3mm, Height 1150mm x Length 400mm x Width 1000mm

Article no.	Weight.	Price (DAP)
67-51-Typ1-AR	14.0 kg	€ 46,00
67-51-Typ1-BL	14.0 kg	€ 46,00
67-51-Typ1-CR	19.5 kg	€ 64,00
67-51-Typ1-DL	19.5 kg	€ 64,00
67-51-Typ2-AR	12.0 kg	€ 39,00
67-51-Typ2-BL	12.0 kg	€ 39,00
67-51-Typ2-CR	17.6 kg	€ 58,00
67-51-Typ2-DL	17.6 kg	€ 58,00
67-51-Typ1-A	14.7 kg	€ 49,00
67-51-Typ1-B	17.5 kg	€ 58,00
67-51-Typ1-C	19.7 kg	€ 65,00
67-51-Typ1-D	21.0 kg	€ 69,00
67-51-Typ2-A	13.1 kg	€ 43,00
67-51-Typ2-B	15.7 kg	€ 52,00
67-51-Typ2-C	18.2 kg	€ 60,00
67-51-Typ2-D	19.4 kg	€ 64,00



These post are Hot Dip Galvanized and Signal yellow coated (RAL1003) with three 3M reflective Jet Black stripes (RAL 9005) furthermore order on customized size is accepted.

Note: Order also accepted with only Hot Dip Galvanizing

Anti-nudge hoop

N



Safety Hoop – protection for posts, pillars, poles, etc.

Anti-nudge hoop for posts



Crash guard with covered



Article. Anti-nudge hoop for plugging down

Anti-nudge hoop Ø 60 x 2.6mm, Height 600mm x Length 600mm x Width 600mm
 Anti-nudge hoop Ø 60 x 2.6mm, Height 800mm x Length 800mm x Width 800mm

Article no.

67-55-Typ1-A
 67-55-Typ1-B

Weight.

18.3 kg
 21.0 kg

Price (DAP)

€ 60,00
 € 69,00

Article. Crash guard with covered for plugging down

Crash guard with covered Ø 76 x 3mm, Height 650mm x Width 750mm
 Crash guard with covered Ø 76 x 3mm, Height 650mm x Width 1000mm

67-90-Typ1-A
 67-90-Typ1-B

18.1 kg
 22.1 kg

€ 60,00
 € 73,00



These post are Hot Dip Galvanized and Signal yellow coated (RAL1003) with 3M reflective Jet Black stripes (RAL 9005) furthermore order on customized size is accepted.

Note: Order also accepted with only Hot Dip Galvanizing



Article. Anti-nudge bar of Ø76mm for plugging down (Refer A)

- Anti-nudge hoop Ø 76 x 3mm, Height 86mm x Width 400mm
- Anti-nudge hoop Ø 76 x 3mm, Height 86mm x Width 800mm
- Anti-nudge hoop Ø 76 x 3mm, Height 86mm x Width 1000mm
- Anti-nudge hoop Ø 76 x 3mm, Height 86mm x Width 1200mm

Article. Corner anti-nudge bar of Ø76mm for plugging down (Refer B)

- Anti-nudge hoop Ø 76 x 3mm, Height 86mm x Width 700 x length 700mm

Article. Anti-nudge hoop of Ø60mm for plugging down (Refer C)

- Anti-nudge hoop Ø 60 x 3mm, Height 115mm x Width 400mm
- Anti-nudge hoop Ø 60 x 3mm, Height 115mm x Width 1000mm
- Anti-nudge hoop Ø 60 x 3mm, Height 115mm x Width 1500mm
- Anti-nudge hoop Ø 60 x 3mm, Height 115mm x Width 2000mm

Article. Anti-nudge hoop for truck pull in assist of Ø152mm for plugging down (Refer D)

- Anti-nudge hoop Ø 152 x 3mm (Left)
- Anti-nudge hoop Ø 152 x 3mm (Right)
- Anti-nudge hoop Ø 152 x 3mm (Straight extension)

Article no.	Weight.	Price (DAP)
67-89-Typ2-A	3.7 kg	€ 12,00
67-89-Typ2-B	5.7 kg	€ 19,00
67-89-Typ2-C	6.7 kg	€ 22,00
67-89-Typ2-D	7.7 kg	€ 25,00
67-90-Typ2	9.0 kg	€ 30,00
67-89-Typ1-A	3.2 kg	€ 10,00
67-89-Typ1-B	5.5 kg	€ 18,00
67-89-Typ1-C	7.5 kg	€ 25,00
67-89-Typ1-D	9.4 kg	€ 31,00
67-90-Typ3-L	59.3 kg	€ 196,00
67-90-Typ3-R	59.3 kg	€ 196,00
67-90-Typ3-S	53.2 kg	€ 176,00



These post are Hot Dip Galvanized and Signal yellow coated (RAL1003) with 3M reflective Jet Black stripes (RAL 9005)

Note: Order also accepted with only Hot Dip Galvanizing



Protective railing - Anti-nudge railing is safety railing for work ways in front of machines, robots, racks, etc. The railing system is available for plugging with or without base plate, removable and post with tilt-able up to 30° (refer page 90)

Steel tube 70 x 70 mm with top and knee bars of steel tube 60 x 40 mm, height approx. 1000 mm, bolted

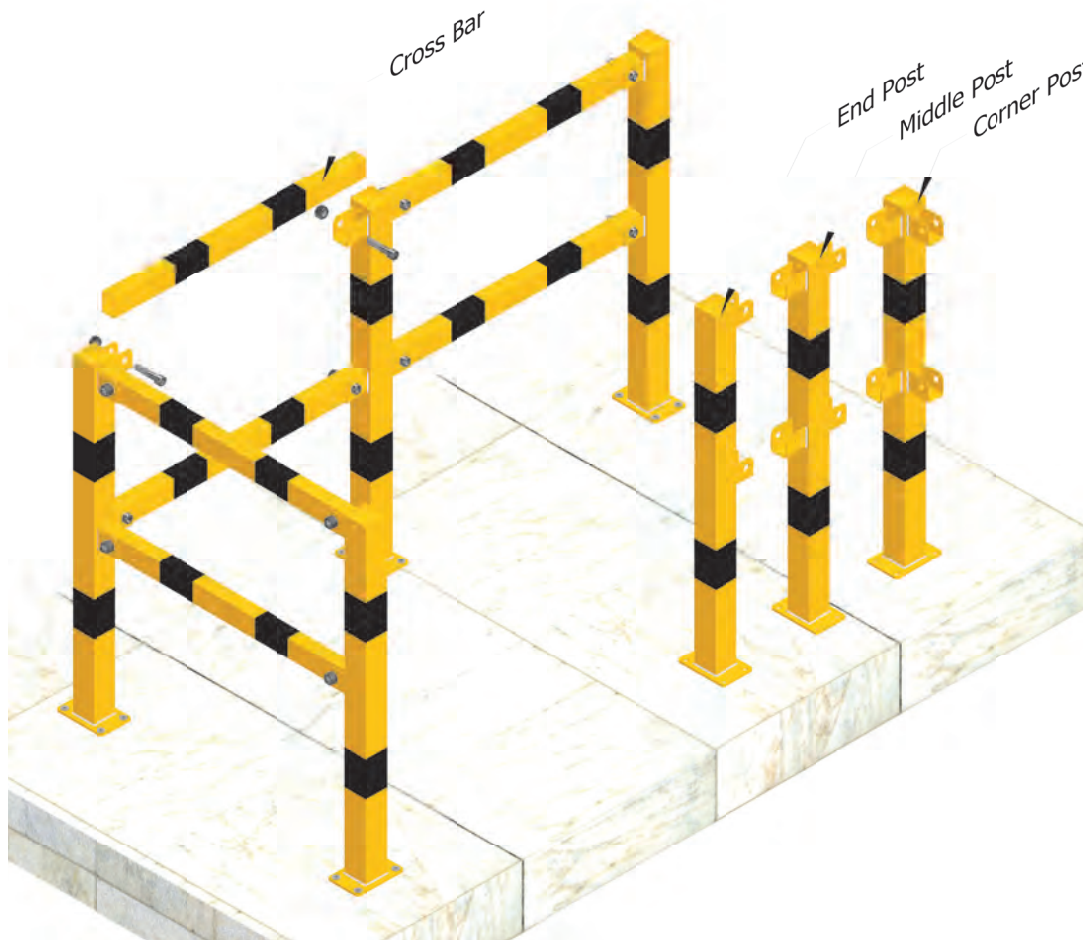

Article. Post for protective railing for plugging down

- End post of Sq. 70 x 70 x 2.5mm
- Middle post of Sq. 70 x 70 x 2.5mm
- Corner post of Sq. 70 x 70 x 2.5mm

Article. Cross bar for protective railing

- Cross bar of Sq. 70 x 70 x 2.5mm = Length 800mm
- Cross bar of Sq. 70 x 70 x 2.5mm = Length 1300mm
- Cross bar of Sq. 70 x 70 x 2.5mm = Length 1800mm
- Cross bar of Sq. 70 x 70 x 2.5mm = Length 2300mm

Article no.	Weight.	Price (DAP)
69-70-Typ1-A	6.5 kg	€ 24,00
69-70-Typ1-B	7.0 kg	€ 26,00
69-70-Typ1-C	7.0 kg	€ 26,00
69-48-P14	3.1 kg	€ 12,00
69-48-P15	5.1 kg	€ 19,00
69-48-P16	7.1 kg	€ 26,00
69-48-P17	9.0 kg	€ 33,00



These post are Hot Dip Galvanized and Signal yellow coated (RAL1003) with 3M reflective Jet Black stripes (RAL 9005)

Note: Order also accepted with only Hot Dip Galvanizing

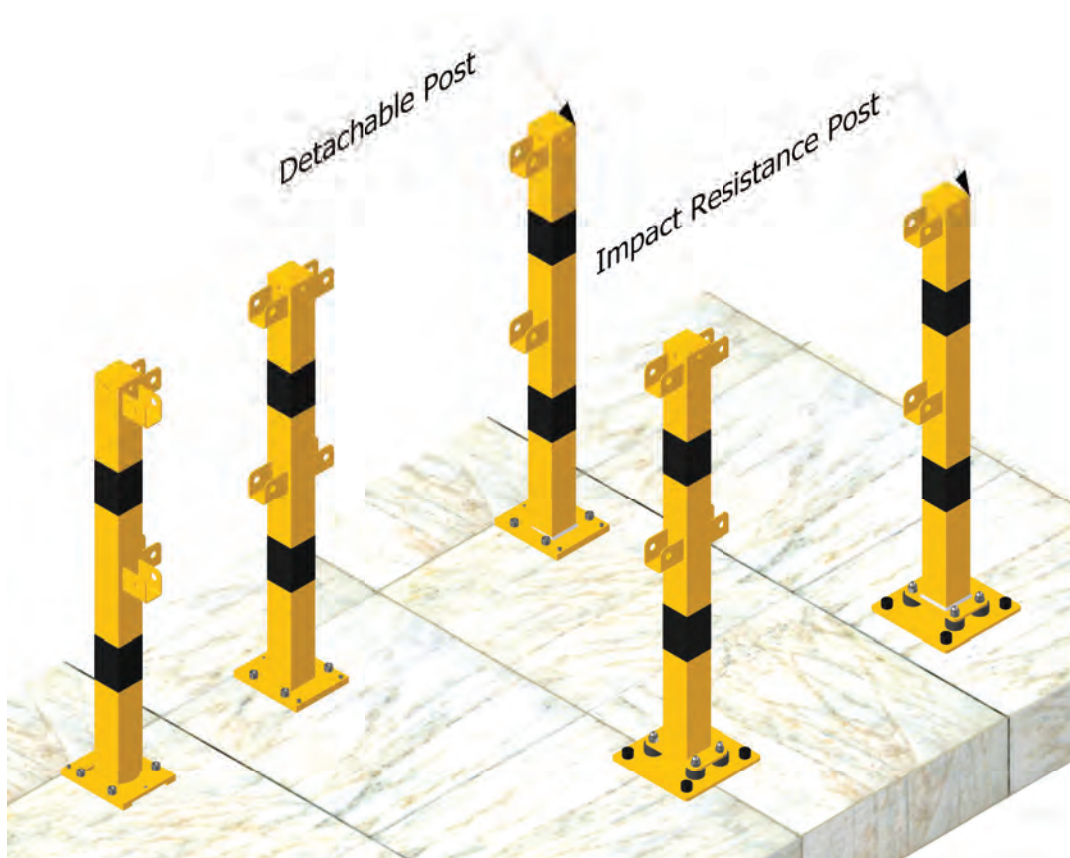

Article. Impact resistance Post for protective railing for plugging down

Impact resistance End post of Sq. 70 x 70 x 2.5mm
 Impact resistance Middle post of Sq. 70 x 70 x 2.5mm

Article no.	Weight.	Price (DAP)
69-70-Typ3-A	10.1 kg	€ 37,00
69-70-Typ3-B	10.5 kg	€ 38,00

Article. Detachable Post for protective railing for plugging down

Detachable End post of Sq. 70 x 70 x 2.5mm
 Detachable Middle post of Sq. 70 x 70 x 2.5mm
 Detachable Corner post of Sq. 70 x 70 x 2.5mm

69-70-Typ2-A	8.5 kg	€ 31,00
69-70-Typ2-B	9.0 kg	€ 33,00
69-70-Typ2-C	9.0 kg	€ 33,00



These post are Hot Dip Galvanized and Signal yellow coated (RAL1003) with 3M reflective Jet Black stripes (RAL 9005)

Note: Order also accepted with only Hot Dip Galvanizing

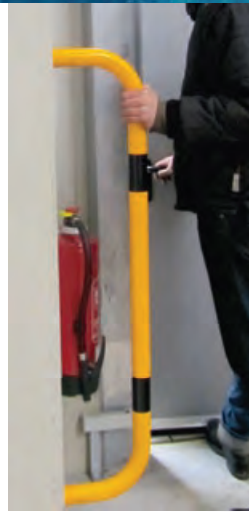

Protective railing - Railing system for universal use, e.g. as internal protective railing to separate traffic aisles or protect terminal boxes, distribution panels, machines, etc. Easy to assembly the parts together and plug down,

Corner Post

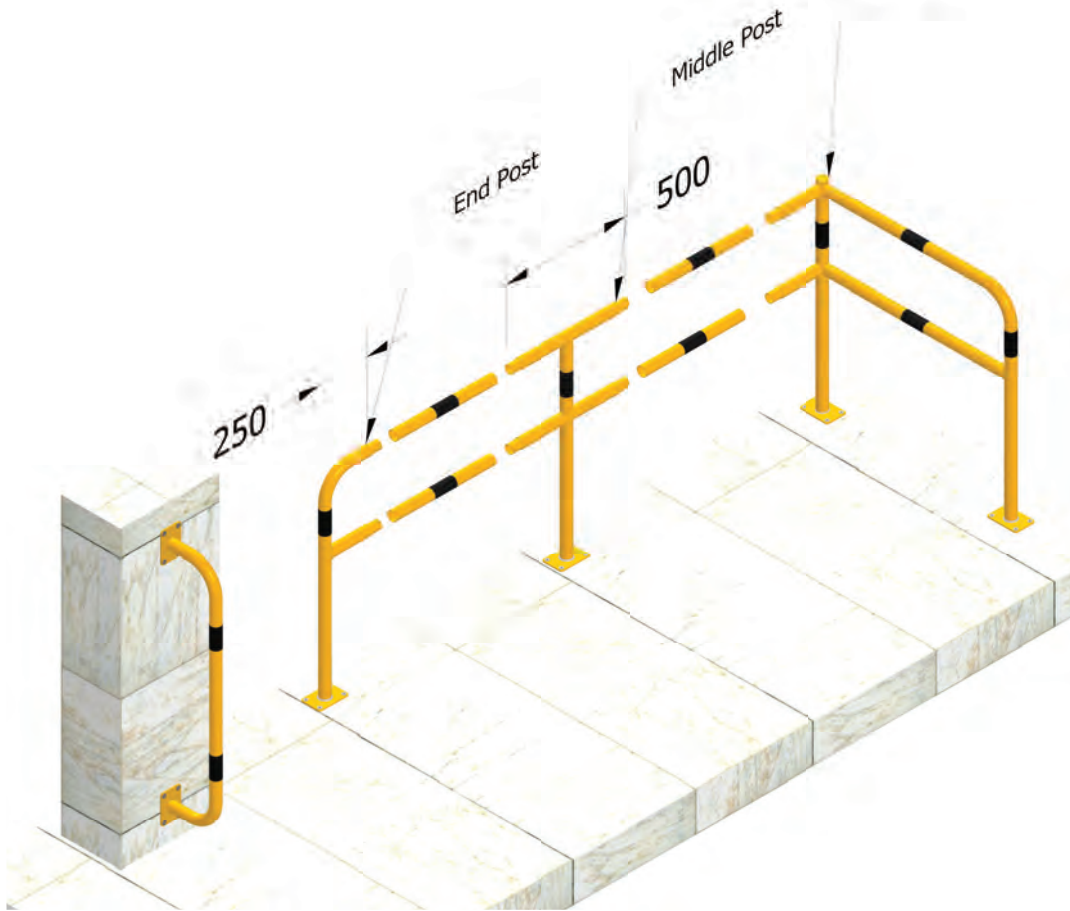

Article. Post for protective railing for plugging down

- End post of Ø 48 x 2.6mm
- Middle post of Ø 48 x 2.6mm
- Corner post of Ø 48 x 2.6mm

Article. Cross bar for protective railing

- Cross bar of Ø 48 x 2.6mm = Length 500mm
- Cross bar of Ø 48 x 2.6mm = Length 1000mm
- Cross bar of Ø 48 x 2.6mm = Length 1500mm

Article. Railing handle wall mounting

- Railing handle, Height 1200mm x Width 250mm
- Railing handle, Height 2000mm x Width 250mm

Article no.	Weight.	Price (DAP)
69-48-Typ1-A	4.9 kg	€ 18,00
69-48-Typ1-B	7.2 kg	€ 27,00
69-48-Typ1-C	7.0 kg	€ 26,00
69-48-P8	1.5 kg	€ 6,00
69-48-P9	3.11 kg	€ 11,00
69-48-P10	4.7 kg	€ 17,00
67-89-Typ3-A	6.1 kg	€ 22,00
67-89-Typ3-B	8.5 kg	€ 31,00



These post are Hot Dip Galvanized and Signal yellow coated (RAL1003) with 3M reflective Jet Black stripes (RAL 9005)

Note: Order also accepted with only Hot Dip Galvanizing

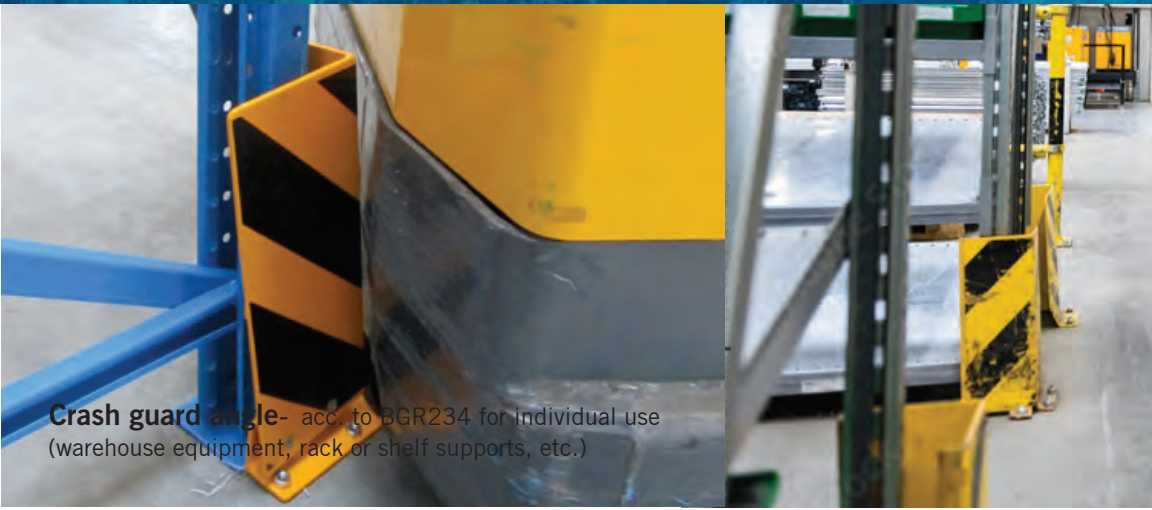

Crash guard angle- acc. to BGR234 for individual use (warehouse equipment, rack or shelf supports, etc.)



Crash guard angle, Article no. 69-47-P9 (Refer A) - To protect shelves and storage racks. The new crash guard can be tilted 15°. This compensates impacts from fork trucks or other vehicles without damage or being torn out of the floor (up to 400Nm pressure).

Refer D

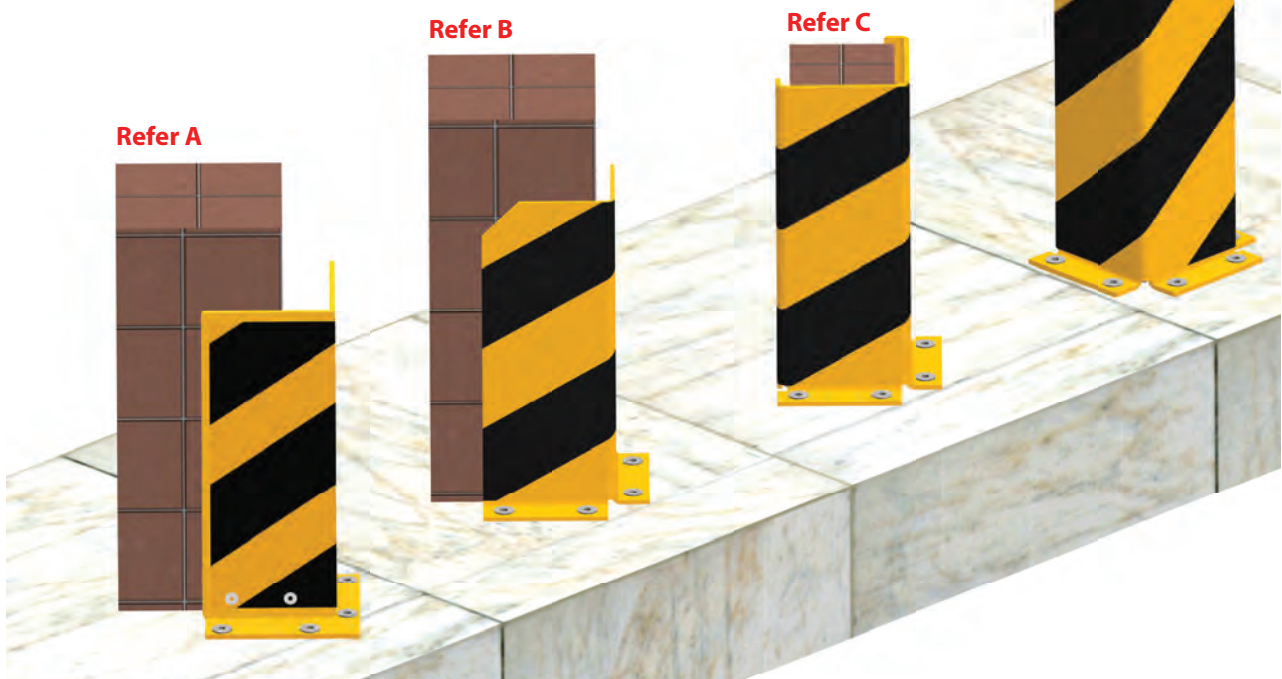

Article. Crash guard angle with impact resistance up to 15° (Refer A)

Impact crash guard, Height 400 x Length 160 x Thickness 6mm

Article. Crash guard angle (Refer B)

Crash guard, Height 200 x Length 160 x Thickness 6mm

Crash guard, Height 400 x Length 160 x Thickness 6mm

Crash guard, Height 800 x Length 160 x Thickness 6mm

Crash guard, Height 1200 x Length 160 x Thickness 6mm

Article. Crash guard angle with reinforced edges (Refer C)

Crash guard, Height 400 x Length 160 x Thickness 6mm

Crash guard, Height 800 x Length 160 x Thickness 6mm

Crash guard, Height 1200 x Length 160 x Thickness 6mm

Article. Crash guard U shape with reinforced edges (Refer D)

Crash guard, Height 400 x Length 160 x width 160 x Thickness 6mm

Article no.	Weight.	Price (DAP)
69-47-Typ4	8.9 kg	€ 33,00
69-47-Typ1-A	3.0 kg	€ 11,00
69-47-Typ1-B	5.5 kg	€ 20,00
69-47-Typ1-C	10.7 kg	€ 40,00
69-47-Typ1-D	16.0 kg	€ 59,00
69-47-Typ2-A	7.5 kg	€ 27,00
69-47-Typ2-B	14.5 kg	€ 54,00
69-47-Typ2-C	21.5 kg	€ 79,00
69-47-Typ3	10.8 kg	€ 40,00



These post are Hot Dip Galvanized and Signal yellow coated (RAL1003) with 3M reflective Jet Black stripes (RAL 9005)

Note: Order also accepted with only Hot Dip Galvanizing

Know INDIA - Valluvar Kottam is a popular monument in Chennai, Tamilnadu, India which is dedicated to the classical Tamil poet, philosopher and saint Thiruvalluvar. Thiruvalluvar wrote his famous Thirukkural





the products shown in this catalogue
designed & manufactured by NavAstrid in chennai

www.navastrid.de

No 88, CTH Road, Veppampattu, TamilNadu, - 602024. INDIA